



Deuschmann

your ticket to all buses

Manual
Universal Fieldbus-Gateway
UNIGATE® CX-CANopen-(Mapping) - DeviceNet



Deuschmann Automation GmbH & Co. KG
www.deuschmann.de | wiki.deuschmann.com

1	Information on CE marking of the module	8
1.1	EU Directive EMC	8
1.2	Scope of application	8
1.3	Note installation guidelines	8
1.4	Installation of the unit	8
1.5	Working on switch cabinets	8
2	Information for the machine manufacturers	9
2.1	Introduction	9
2.2	EU Machinery Directive	9
3	Introduction	10
4	Operation modes of the Gateway	11
4.1	Run mode	11
4.2	Data exchange mode	11
4.3	Device configuration	11
4.4	Debug mode	11
5	The Debug-interface	12
5.1	Overview of the Debug-interface	12
5.2	Starting in the Debug-mode	12
5.3	Communication parameter for the Debug-interface	12
5.4	Possibilities with the Debug-interface	12
5.5	Commands of the Debug-interface	12
6	Mode of operation of the system	13
6.1	General explanation	13
6.2	Interfaces	13
6.3	Data exchange	13
6.4	Possible data lengths	13
6.5	Startup phase	13
7	Implemented protocols in UNIGATE® CX C4Map	14
7.1	Implemented protocols at CANopen interface	14
7.1.1	Functionality of the individual transport protocols	14
7.1.2	CANopen Mapping	14
7.1.2.1	Configuration of the mapping	15
7.1.2.2	Node Guarding	16
7.1.2.3	Display of the node guarding states	17
7.1.2.4	Emergency Messages	17
7.1.2.5	Gateway Control Byte	18
7.1.2.6	Bit 7 (MSB): EMCY Toggle Bit	18
7.1.2.7	Bit 6: Set Operational Toggle Bit	18
7.1.2.8	Bit 5: RTR - Request to response	18
7.1.2.9	Gateway Error Byte	18
7.1.2.10	SDO Obj Mapping	19
7.1.2.11	Slave Mode	20
7.1.2.12	CAN Fieldbus address	20
7.1.2.13	Communication cycle period (object 1006h)	21
7.1.2.14	Start phase	21
7.1.2.15	Data throughput time	21

7.2	Implemented Protocols - DeviceNet	22
7.2.1	Protocol Delta exchange	22
7.3	The trigger byte	23
7.4	The length byte	23
7.5	Swap word	23
8	Hardware ports, switches and LEDs CANopen (Mapping)	24
8.1	Device labeling	24
8.2	Connectors	24
8.2.1	Connector to the external device (RS-interface)	24
8.2.2	Connector supply voltage and DEBUG-interface	25
8.2.3	CANopen [®] -connector	25
8.2.4	Power supply	25
8.3	LEDs	25
8.3.1	LED "(Bus) Power"	25
8.3.2	LED "(Bus) State"	26
8.3.3	LED "Power"	27
8.3.4	LED "State"	27
8.3.5	LEDs 1 / 2 / 4 / 8 (Error No / Select ID)	27
8.4	Switches	27
8.4.1	Rotary coding switches S4 + S5 (serial interface)	27
8.4.2	Termination (CANopen [®])	28
8.4.3	DIP-Switch	28
8.5	Debug cable for UNIGATE [®] CL	28
9	Hardware ports, switches and LEDs DeviceNet	29
9.1	Device labeling	29
9.1.1	Connectors	29
9.1.1.1	Connector service interface	29
9.1.1.2	Connector supply voltage and DEBUG-interface	30
9.1.1.3	DeviceNet-connector	30
9.1.1.4	Power supply	30
9.2	LEDs	30
9.2.1	LED "(Bus) Power"	30
9.2.2	LED "(Bus) State"	30
9.2.3	LED "Power"	31
9.2.4	LED "State"	31
9.2.5	LEDs 1 / 2 / 4 / 8 (Error No. / Select ID)	31
9.3	Switches	31
9.3.1	Rotary coding switches S4 + S5 (serial interface)	31
9.3.2	Termination (DeviceNet)	31
9.3.3	DIP-switch	32
9.4	The Debug cable for UNIGATE [®] CL	32
10	Error handling	33
10.1	Error handling at UNIGATE [®] C4Map	33
10.2	Error handling at UNIGATE [®] CL-DeviceNet	34
11	Installation guidelines	35
11.1	Installation of the module	35

11.1.1	Mounting	35
11.1.2	Removal	35
11.2	Wiring	35
11.2.1	Connection systems - DeviceNet	35
11.2.2	Connection systems - CANopen	35
11.2.2.1	Power supply	36
11.2.2.2	Equipotential bonding connection	36
12	CANopen® communication interface	37
12.1	Bus line with copper cable	37
12.2	Line routing, shield and measures to combat interference voltage	37
12.3	General information on line routing	37
12.3.1	Shielding of lines	38
13	CANopen®	39
13.1	Description CANopen®	39
13.1.1	CANopen® V4	39
14	Communication interface DeviceNet	41
14.1	Bus line with copper cable	41
14.2	Line routing, shield and measures to combat interference voltage	41
14.2.1	General information on line routing	41
14.2.1.1	Shielding of lines	41
15	DeviceNet	43
15.1	The Product Code	43
15.2	EDS file	43
15.3	DeviceNet™ information	43
16	Technical data	44
16.1	Device data	44
16.1.1	Interface data	45
17	Commissioning guide	46
17.1	Note	46
17.2	Components	46
17.3	Installation	46
17.4	Dimensional drawing UNIGATE® CX-C4Map-DN	46
17.5	Commissioning	46
17.6	Setting the CANopen® address and baud rate	47
17.6.1	CANopen® connection	47
17.6.2	Connection to the process device	47
17.6.3	Connecting the supply voltage	47
17.6.4	Shield connection	47
17.6.5	Project planning	47
17.7	Setting the DeviceNet™ address and baud rate	47
17.8	DeviceNet™ connection	47
17.9	Connection to the process device	47
17.10	Connecting the supply voltage	47
17.11	Shield connection	48
17.12	Project planning	48

18 Servicing	49
18.1 Returning a device	49
18.2 Downloading PC software	49
19 Annex	50
19.1 Explanations of the abbreviations	50
19.2 Hexadecimal table	51

Disclaimer of liability

We have checked the contents of the document for conformity with the hardware and software described. Nevertheless, we are unable to preclude the possibility of deviations so that we are unable to assume warranty for full compliance. The information given in the publication is, however, reviewed regularly. Necessary amendments are incorporated in the following editions. We would be pleased to receive any improvement proposals which you may have.

Copyright

Copyright (C) Deutschmann Automation GmbH & Co. KG 1997 – 2021. All rights reserved. This document may not be passed on nor duplicated, nor may its contents be used or disclosed unless expressly permitted. Violations of this clause will necessarily lead to compensation in damages. All rights reserved, in particular rights of granting of patents or registration of utility-model patents.

1 Information on CE marking of the module

1.1 EU Directive EMC

The following applies to the module described in this User Manual:

Products which bear the CE mark comply with the requirements of EU Directive „Electromagnetic Compatibility“ and the harmonized European Standards (EN) listed therein.

The EU Declarations of Conformity are available at the following location for perusal by the responsible authorities in accordance with the EU Directive, Article 10:

Deutschmann Automation GmbH & Co. KG, Carl-Zeiss-Straße 8, 65520 Bad Camberg, Germany.

1.2 Scope of application

The modules are designed for use in the industrial sector and comply with the following requirements.

Scope of application	Requirement applicable to	
	Emitted interference	Interference immunity
Industry	EN 55011, cl. A (2007)	EN 61000-6-2 (2005)

1.3 Note installation guidelines

The module complies with the requirements if you

1. comply with the installation guidelines described in the User Manual when installing and operating the module.
2. also follow the rules below on installation of the equipment and on working on switch cabinets.

1.4 Installation of the unit

Modules must be installed in electrical equipment rooms/areas or in enclosed housings (e.g. switch boxes made of metal or plastic). Moreover, you must earth the unit and the switch box (metal box) or at least the top-hat rail (plastic box) onto which the module has been snapped.

1.5 Working on switch cabinets

In order to protect the modules against static electrical discharge, the personnel must discharge themselves electrostatically before opening switch cabinets or switch boxes.

2 Information for the machine manufacturers

2.1 Introduction

The UNIGATE® module does not constitute a machine as defined by the EU "Machinery" Directive. Consequently, the module does not have a Declaration of Conformity in relation to the EU Machinery Directive.

2.2 EU Machinery Directive

The EU Machinery Directive stipulates the requirements applicable to a machine. The term "machine" is taken to mean a totality of connected parts or fixtures (see also EN 292-1, Paragraph 3.1)

The module is a part of the electrical equipment of the machine and must thus be included by the machine manufacturer in the Declaration of Conformity process.

3 Introduction

The UNIGATE® CX-CANopen (Mapping) - DeviceNet module serves to adapt a CANopen interface to DeviceNet™ according to „DeviceNet Specification Release 2.0“. In this application it acts as a gateway and works as DeviceNet „Group 2 Only Slave“. It can be operated by any standard-compliant master.

The module CX-C4Map-DN essentially consists of the following hardware components:

- Electrically isolated interface to DeviceNet
- CAN-controller SJA 1000
- Microprocessor 89C51RD2
- RAM and EPROM
- Serial interfaces RS232 (Service interfaces)
- Electrically isolated interface to CANopen
- Debug interfaces (for device configuration)

Conceptual



C4Map stands for CANopen with CANopen (mapping) functionality.



In the further course of this manual, the term "Fieldbus" is frequently used. In these cases this applies to the DeviceNet interface.

4 Operation modes of the Gateway

4.1 Run mode

When delivered, the UNIGATE® CX is in RUN mode. The following functions can be used in RUN mode:

- Data exchange
- Device configuration
- Debug mode

4.2 Data exchange mode

In data exchange mode, the data is transmitted bidirectionally between the two respective fieldbus systems. The data exchange mode is only active if neither the device configuration nor the debug mode is used.

4.3 Device configuration

In RUN mode it is possible to configure the device. The configuration is done with the configuration software WINGATE via the DEBUG interfaces of the device. The DEBUG Interfaces are RS232 interfaces. They are located on X1 and X2 on pin 2 (0V Pwr) + pin 3 (Rx debug) + pin 4 (Tx debug).

Note: Pin 2 (0V Pwr) is also the 0V power supply for the device. In addition, the two rotary switches S4 and S5 must be set to the "0" position. The menu items "Extras" -> "Upload_Config_Debug" or "Download_Config_Debug" are used to read and write the configuration in WINGATE. The exact procedure for device configuration is described in the WINGATE manual in the chapters "Connection UNIGATE® via the debug interface" and "Configuration via the debug interface".

4.4 Debug mode

In RUN mode, it is possible to execute a script that is programmed with the Software Protocol Developer step by step. Debugging is done with the Software Protocol Developer via the debug interfaces of the device. The debug interfaces are RS232 interfaces. The debug interfaces are located on X1 and X2 on pin 2 (0V Pwr) + pin 3 (Rx debug) + pin 4 (Tx debug). Note: Pin 2 (0V Pwr) is also the 0V power supply for the device. In addition, the two rotary switches S4 and S5 must be set to the "0" position.

Attention: This is only necessary for the development of a script. For more information, please refer to the online help of the Protocol Developer.

5 The Debug-interface

5.1 Overview of the Debug-interface

The UNIGATE® features a Debug-interface, that allows a step-by-step processing of a Script. Normally this interface is only required for the development of a Script.

5.2 Starting in the Debug-mode

When applying power to the UNIGATE® (power up) the firmware will output the binary character 0 (0x00) after a self-test was carried out on this interface. If the UNIGATE® receives an acknowledgement via this interface within 500 ms, it is in the Debug-mode. The acknowledgement is the ASCII-character O (0x4F).

With the start in the Debug-mode the further execution of Script commands will be put to a stop.

5.3 Communication parameter for the Debug-interface

The Debug-interface is always operating with 9600 baud, no parity, 8 data bit, 1 stop bit. It is not possible to change this parameter in the Protocol Developer. Please consider the fact that these settings have to be in accordance with those of the PC-COM-interface and that the flow control (protocol) has to be set on „none“ there.

5.4 Possibilities with the Debug-interface

Usually the Protocol Developer is connected to the Debug-interface. With it a step-by-step processing of a Script, monitoring jumps and decisions and looking at memory areas is possible. Moreover breakpoints can be set. It basically possesses all characteristics a software-development tool is typically supposed to have. However, it is also possible to carry out a Scrip-update via this interface.

From Script version [27] on you can also output data with the Script command "SerialOutputToDebugInterface". Please also pay attention to the remark in the manual 'Protocol Developer'.

5.5 Commands of the Debug-interface

The commands for the use of the Debug-interface are described in the instruction manual Protocol Developer.

6 Mode of operation of the system

6.1 General explanation

Communication can be split into seven layers, Layer 1 to Layer 7, in accordance with the ISO/OSI model.

The Deutschmann Automation Gateways convert Layers 1 and 2 of the customized bus system (RS485 / RS232 / RS422) to the corresponding Fieldbus system. Layers 3 to 6 are blank, and Layer 7 is converted in accordance with chapter 25.3.

6.2 Interfaces

The Gateway features a CANopen and fieldbus interface as well as the serial interfaces RS232-, RS422- and RS485.

6.3 Data exchange

All data is transferred by the Gateway in dependence of the downloaded Script.

6.4 Possible data lengths

The table below shows the maximum transferable data:

Data length on DeviceNet-Side			
DeviceNet	Input data (Consumed)	max. 255 bytes	Variable: maximum value in this case
	Output data (Produced)	max. 255 bytes	Variable: maximum value in this case

Data length on CANopen-Side		
C4Map		CANopen Mapping
	In- and Output data	a maximum of 10 bytes, of which a maximum of 8 bytes of user data

6.5 Startup phase

The Gateway is parameterized and configured by the Master during the startup phase. Only after a correct termination of the startup phase the data exchange with external devices will take place.

7 Implemented protocols in UNIGATE® CX C4Map

The protocols “CANopen (mapping)” and “Delta exchange” are required for communication.

7.1 Implemented protocols at CANopen interface

CANopen Mapping



Note: Data exchange is only possible when the DeviceNet is in "Data Exchange".

7.1.1 Functionality of the individual transport protocols

7.1.2 CANopen Mapping

Data structure

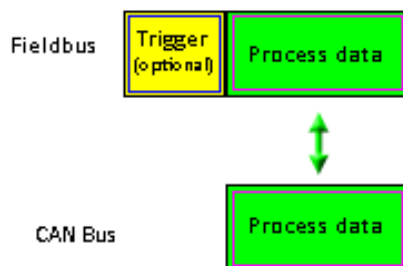

The mapping in the gateway can be configured using the supplied WINGATE® software. This gateway module from the UNIGATE series from Deutschmann Automation allows a coupling between **fieldbus** and **CANopen**®.

The gateway behaves on the CANopen® side as a standard-compliant master and on the DeviceNet side as a standard-compliant slave.

Data exchange

The data exchange between fieldbus and CANopen® is carried out by the mapping that is configured with "WINGATE®".

Mapping is the mapping of data from a fieldbus to any other fieldbus. All data provided by the corresponding buses can serve as data here.

The mapping works in both directions, i.e. both from master to slave and vice versa.

Example:

For example, it can be specified that the 2nd byte of the COB-ID201 (CANopen® node) is transferred as the 7th byte in the fieldbus data.

256 mappings are currently possible (128 Tx and 128 Rx mappings). The data is transferred as PDOs. A maximum of 16 Tx and 16 RX PDOs can be set. Each PDO can have up to 8 bytes (i.e. 8 mappings). 16 PDO * 8 bytes = 128 mappings. SDO access is also supported (see chapter 7.1.2.10).

7.1.2.1 Configuration of the mapping

To create or edit such a mapping, connect the UNIGATE® in configuration mode (see Chapter 23.3) to the PC via the RS232 interface and start the "WINGATE®" software there. After starting the software, an upload from the connected device is carried out automatically. The relevant parameters for this device are shown. Double-click the "map ..." value. After a short time a dialog is displayed with which you can edit all map entries of the gateway, similar to the following image:

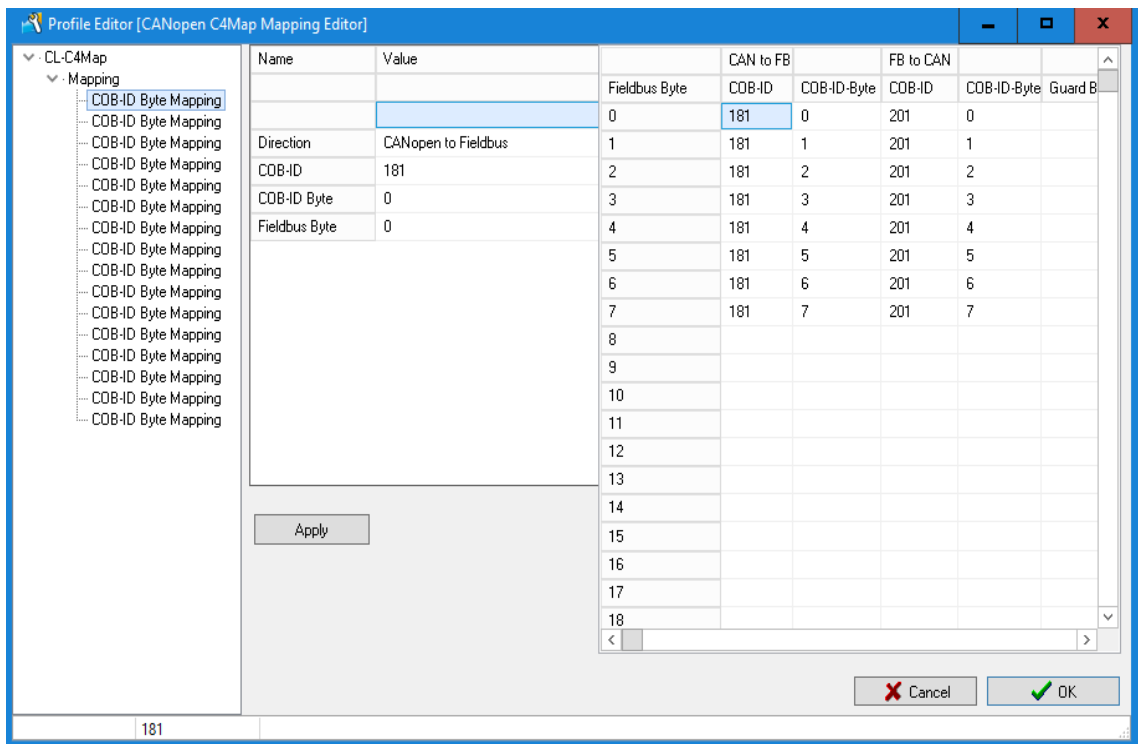

You can now change the mappings, delete them or add new ones (right mouse button). Alternatively, the values can also be entered in the table on the right. The entry must be confirmed with "Apply", only then are the values accepted. Then you only have to download the data to the gateway (Menu Extras\Write configuration via debug interface) and the UNIGATE® works with the new configuration.



It is permitted to map the same byte of a PDO several times to different positions in the fieldbus. However, a maximum of 8 mappings can be entered per PDO!



When mapping from fieldbus to CANopen®, several mappings can be configured for each fieldbus byte. The total number of these multiple mappings must not exceed 31.



Only COB-IDs from the range 101H..580H can be used for the PDO mappings (see DS301 specification for CANopen®).

7.1.2.2 Node Guarding

If a CANopen® slave is monitored via node guarding, the CANopen® master cyclically receives the node guard request to respond to the request. The slave in turn replies to this node guarding request with the corresponding response. Both master and slave can monitor each other in this way.

If the slave does not receive a node guard request, it will assume that the bus connection has been interrupted or that the master has failed.

Settings

The default for all slaves is that no node guarding is carried out. If node guarding is to be activated for a slave, an entry "enable node guarding" must be added to the current configuration in WINGATE for each slave. The parameters "node ID", "guarding time" and "life time factor" must be determined in each entry.

<ul style="list-style-type: none"> ▼ · CL-C4Map > · Mapping ▼ · Node Guarding └─ enable Node Guarding 	<table border="1"> <thead> <tr> <th>Name</th> <th>Value</th> </tr> </thead> <tbody> <tr> <td> </td> <td> </td> </tr> <tr style="background-color: #e6f2ff;"> <td> </td> <td> </td> </tr> <tr> <td>node ID</td> <td>1</td> </tr> <tr> <td>guarding time (ms)</td> <td>1000</td> </tr> <tr> <td>life time factor</td> <td>3</td> </tr> </tbody> </table>	Name	Value					node ID	1	guarding time (ms)	1000	life time factor	3
Name	Value												
node ID	1												
guarding time (ms)	1000												
life time factor	3												

Settings for node guarding

The parameter node ID specifies the ID of the CANopen® node on which monitoring is to take place. The guarding time is the interval in milliseconds in which the master requests the slave to send its guarding response.

The Life Time Factor tells how many times the slave's response may fail to appear before the master assumes that the slave has failed.

7.1.2.3 Display of the node guarding states

Node guard mapping is used to display the node guard states of the individual slaves to the fieldbus. 8 slaves are always represented in one byte; So exactly one bit of information is reserved for a slave. This information can be displayed anywhere in the fieldbus data of the gateway, i.e. it is shown in the input area of the fieldbus master for this gateway.

<ul style="list-style-type: none"> CL-C4Map <ul style="list-style-type: none"> Mapping <ul style="list-style-type: none"> Node Guard Mapping Node Guarding Node Control 	<table border="1"> <thead> <tr> <th>Name</th> <th>Value</th> </tr> </thead> <tbody> <tr> <td>Guard Byte</td> <td>Node 1-8</td> </tr> <tr> <td>Fieldbus Byte</td> <td>2</td> </tr> </tbody> </table>	Name	Value	Guard Byte	Node 1-8	Fieldbus Byte	2
Name	Value						
Guard Byte	Node 1-8						
Fieldbus Byte	2						

Display of the node guarding information

Distribution of the bits for nodes 1- 8:

node 1-8

Byte MSB (Bit 7)	...	LSB (Bit 0)
Slave node ID 8	...	Slave node ID 1

If no node guard is activated for a slave, the slave has failed or no node guarding information has been exchanged, the corresponding bit for this slave is 0. The bit is 1 if node guarding was activated for this slave and the slave for the node Guarding requests answered in the appropriate time.

Example: Node guarding is activated for nodes 1 and 2. Slave 1 does not respond to node guarding, slave ID 2 works normally. A mapping of the information in the fieldbus is entered in the 2nd byte.

Fieldbus data of the Gateway:

Byte 0	Byte 1	Byte 2	Byte 3	Byte 4
xx	xx	0x02	xx	xx

7.1.2.4 Emergency Messages

The gateway can receive up to 10 emergency messages from all slaves for which node guarding has been activated and writes them to a queue. At the same time, an internal counter is increased that contains the number of EMCY messages received. Both the data of the current message and the number of EMCY messages received and the Node ID of the sender of the message can be displayed in the fieldbus output data of the gateway. The next message can be called up via the control byte. If the data of the EMCY message are shown in the bus data, the new data is already visible in the fieldbus when the data is toggled.

<ul style="list-style-type: none"> CL-C4Map <ul style="list-style-type: none"> Mapping <ul style="list-style-type: none"> Emergency Data Mapping Node Control <ul style="list-style-type: none"> Gateway Control Byte 	<table border="1"> <thead> <tr> <th>Name</th> <th>Value</th> </tr> </thead> <tbody> <tr> <td>Emergency Data</td> <td>EMCY Message Byte 0</td> </tr> <tr> <td>Fieldbus Byte</td> <td>0</td> </tr> </tbody> </table>	Name	Value	Emergency Data	EMCY Message Byte 0	Fieldbus Byte	0
Name	Value						
Emergency Data	EMCY Message Byte 0						
Fieldbus Byte	0						

Setting the emergency messages

7.1.2.5 Gateway Control Byte

Some properties of the gateway can be controlled by fieldbus data. For this purpose, the information must be transferred from the fieldbus to the gateway, i.e. it must be in the gateway's entrance area. The data can only be evaluated by the gateway if this information is mapped from the fieldbus to the gateway.

<ul style="list-style-type: none"> CL-C4Map <ul style="list-style-type: none"> > Mapping > Node Guarding Node Control <ul style="list-style-type: none"> Gateway Control Byte Gateway Error Code 	<table border="1" style="width: 100%; border-collapse: collapse;"> <thead> <tr> <th style="width: 50%;">Name</th> <th style="width: 50%;">Value</th> </tr> </thead> <tbody> <tr> <td> </td> <td> </td> </tr> <tr style="background-color: #e0f0ff;"> <td> </td> <td> </td> </tr> <tr> <td>Fieldbus Byte</td> <td>0</td> </tr> </tbody> </table>	Name	Value					Fieldbus Byte	0
Name	Value								
Fieldbus Byte	0								

Settings Gateway Control Byte

Gateway Control Byte							
Bit 7	Bit 6	Bit 5	res.	res.	res.	res.	res.
EMCY toggle bit	Set OP toggle bit	Request to response					

7.1.2.6 Bit 7 (MSB): EMCY Toggle Bit

With this bit, the next EMCY message can be transferred to the current data buffer, regardless of whether the data is displayed in the fieldbus or not. The counter is decremented by 1 if it is not 0.

7.1.2.7 Bit 6: Set Operational Toggle Bit

If this bit is changed, the gateway sends the Set Operational message to the slaves. This feature is to be used when some slaves are slower than the master and are only ready when the master has already sent this message.

7.1.2.8 Bit 5: RTR - Request to response

With this bit (transition from 0 -> 1) RTR telegrams can be sent to all PDOs mapped as Rx. This RTR means that the addressed PDOs are sent and thus updated in the gateway. If the RTR functionality is used, at least 1 Rx PDO must be mapped. Furthermore, no more than 50 Rx PDOs may be mapped, otherwise an overrun will occur.

7.1.2.9 Gateway Error Byte

The current error status of the gateway itself, like the other values of the node guarding or the slave data, can be mapped in the fieldbus.

<ul style="list-style-type: none"> CL-C4Map <ul style="list-style-type: none"> > Mapping > Node Guarding Node Control <ul style="list-style-type: none"> Gateway Control Byte Gateway Error Code 	<table border="1" style="width: 100%; border-collapse: collapse;"> <thead> <tr> <th style="width: 50%;">Name</th> <th style="width: 50%;">Value</th> </tr> </thead> <tbody> <tr> <td> </td> <td> </td> </tr> <tr style="background-color: #e0f0ff;"> <td> </td> <td> </td> </tr> <tr> <td>Fieldbus Byte</td> <td>0</td> </tr> </tbody> </table>	Name	Value					Fieldbus Byte	0
Name	Value								
Fieldbus Byte	0								

Setting Error Byte

7.1.2.10 SDO Obj Mapping

SDO transmission via a "window" in the fieldbus (FB). The following fixed data record structure is used in the FB, which is mapped into the FB data from the FB index. A distinction is made between:

- FB-Idx (In) = data from the FB master (PLC) to the UNIGATE
- FB-Idx (Out) = data on the FB master (PLC) from the UNIGATE

The user must ensure that enough space is reserved in the FB data for the longest data record. SDO transmission is always initiated by the FB master and is ended when the job number in the FB output data is identical to the job number in the FB input data.

Data record structure (FB input = data from FB master):

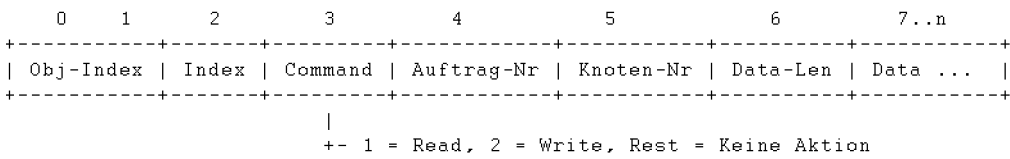

Data record structure (FB output = data on the FB master):

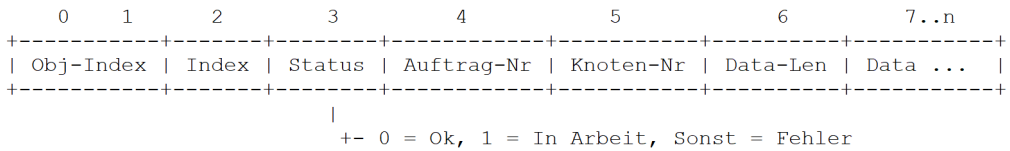

Beispiel:

- CL-C4Map
- > · Mapping
- > · Node Guarding
- > · Node Control
- v · SDO
 - SDO Obj Mapping

Name	Value
FB-Idx (In)	8
FB-Idx (Out)	8

In this example FB-Idx (In) und FB-Idx (Out) = 8

Please note:

The counting starts with index "0" = 1st byte, i. H. in our example the "8" corresponds to the 9th byte!

We want to query the manufacturer hardware version of a connected CANopen® slave (object index 1009h). The CANopen® slave has the node ID = 5.

Data-Len Request should be chosen as large as the maximum expected receive data length! Otherwise, the data remaining according to the set length will be capped. If the Data-Len request is equal to or greater than the received data length, the actual data length is returned as the Data-Len response.

Data from the FB master (PLC)

FB Master (PLC) data

Request

Response

FB-Idx (In)	Data (Hex)	Description	FB-Idx (In)	Data (Hex)	Description
0	...	1. Byte	0	...	1. Byte
1	...	2. Byte	1	...	2. Byte
2	...	3. Byte	2	...	3. Byte
3	...	4. Byte	3	...	4. Byte
4	...	5. Byte	4	...	5. Byte
5	...	6. Byte	5	...	6. Byte
6	...	7. Byte	6	...	7. Byte
7	...	8. Byte	7	...	8. Byte
8	10	Obj-Index	8	10	Obj-Index
9	09	Obj-Index	9	09	Obj-Index
10	00	Sub-Index	10	00	Sub-Index
11	01	Command (1 = read)	11	00	Status (0 = ok)
12	01	Auftrag-Nr (1. Auftrag)	12	01	Auftrag-Nr (1. Auftrag)
13	05	Knoten-Nr (Node-ID = 5)	13	05	Knoten-Nr (Node-ID = 5)
14	02	Data Len (Datenlänge = 2)	14	02	Data Len (Datenlänge = 2)
15	...	Data...	15	47	Data... (47h = Hardw.Vers. „G“)
16	...	17. Byte	16	...	17. Byte

7.1.2.11 Slave Mode

The slave mode can be activated via WINGATE. If the slave mode is "enabled", only the start sequence of the master function is not transmitted. It is not a standard-compliant CANopen® slave and no EDS file is supplied.

Profile	map ...
Slave Mode	Enabled
Node-ID	1

7.1.2.12 CAN Fieldbus address

Via WINGATE the CAN fieldbus address can e.g. can be set for slave mode. This is only active when the dip switch on the front of the device is in position "0"

Profile	map ...
Slave Mode	Enabled
Node-ID	1

7.1.2.13 Communication cycle period (object 1006h)

This object provides the communication cycle time. This period defines the SYNC interval.

The function can be permanently activated via the Sync. Time (ms) Obj 1006h can be activated or set with WINGATE or temporarily via third-party engineering software.

With WINGATE you can use the Sync. Time (ms) Obj 1006h a time can be set in milliseconds (ms). With the value "0" the function is inactive.

Profile	Map ...
Slave Mode	Disabled
Node-ID	1
Sync.Time(ms) Obj 1006 h	1000

7.1.2.14 Start phase

The UNIGATE® sends the NMT command "BusStart" every 2 seconds during the start phase; i.e. all connected CANopen® slaves are set to the "Operational" state.

As soon as the UNIGATE® has received the first PDO that is present in the mapping, this start phase is exited; i.e. the NMT command is no longer sent.

There is no timeout here because the CANopen® slaves do not have to react to this NMT command.

If a CANopen® slave is later connected to the network, it no longer receives this NMT command. However, it can be triggered again at any time via the FB command byte (bit 6) in order to also set later CANopen® slaves to the "Operational" state.

7.1.2.15 Data throughput time

Processing times of the data through the gateway:

The actual throughput time of the data from CANopen® to the fieldbus or vice versa depends, among other things, on the following parameters:

- Number of mappings
- Length of the configured PROFIBUS data
- Number of COB IDs used in the mappings
- Number of changed PROFIBUS data between 2 transmissions
- Number of bytes mapped in a COB ID
- Baud rate in PROFIBUS or CAN

Due to these many parameters and the interdependencies of the parameters, no calculation formula for the lead time can be specified. From practical measurements, lead times from 10 ms to 100 ms were observed, the maximum time being measured with a PB configuration of 244 bytes I / O and 488 mappings.

In practice, under "normal" conditions, a lead time of a few milliseconds can be expected. To optimize the lead time, the following guidelines should be followed:

- Number of mappings as small as possible
- Length of the fieldbus configuration as short as possible
- Use all 8 bytes in the COB-IDs if possible => use as few COB-IDs as possible

7.2 Implemented Protocols - DeviceNet

In addition to the "Delta exchange" protocol, the universal script also contains other protocols. However, these cannot be used for communication with the "CANopen (Mapping)" protocol.

7.2.1 Protocol Delta exchange

The Delta exchange protocol can only be used from version 1.9.0 of the universal script Deutschmann.

With this protocol, data can be specifically copied to an area on the fieldbus output side, i.e. from the UNIGATE® to the PLC.

To do this, two control parameters, the address offset and the number of bytes, are required at the start of the transfer before the actual user data then follows. First comes the address offset (Word), then the number of bytes (Word), then the user data as a byte array.

The two parameters (address offset and number of bytes) must be sent with every data transfer.

1st byte address offset high
2nd byte address offset low
3rd byte number of bytes high
4th byte number of bytes low
5th byte user data 1st byte
6th byte "2nd byte
7. "...

Example:

1st byte 0x00
2nd byte 0x02
3rd byte 0x00
4th byte 0x05
5th byte 0x01
6th byte 0x02
7th byte 0x03
8th byte 0x04
9th byte 0x05

In the fieldbus output data (e.g. PROFIBUS), the data is sent to the PLC as follows
sent: 0x00 0x00 0x01 0x02 0x03 0x04 0x05 0x00 ...

Attention: From Universalscript version 1.11.1 on the protocol has changed to a master-slave protocol. Here the 2nd bus side is the master.

The C4Map side only responds when a valid telegram is received. The received telegram can be sent without process data.

Example: the 2nd bus side sends to the C4Map side: 0x00 0x00 0x00 0x00 0xFF

The C4Map page always replies with the full length, even if the content of the process data has not changed.

If the 2nd bus side does not receive a valid response within 4 seconds (timeout 4000 ms), the data received up to that point are discarded. An error message is an output as a diagnosis on the debug interface and a new request with the above empty telegram is sent.

If the C4Map side receives an invalid telegram, it is signalled by error 13 on the error LEDs.

7.3 The trigger byte

If data is transferred cyclically via DeviceNet (which is usually not the case), the gateway must detect when the user wishes to send new data via the serial interface. For this reason, the user can set control of transmission via a trigger byte (data exchange → On Trigger). In this mode, the gateway always sends (and only then) when the trigger byte is changed.

If the Trigger-Byte mode is activated, the gateway increments the trigger byte each time a telegram has been received.

The first byte in the DeviceNet input/output data buffer is used as the trigger byte if this mode is activated.

7.4 The length byte

The user can configure whether the transmit length is also to be stored as a byte in the input/output data area (Fieldbus lengthbyte → active). In transmit direction, as many bytes as specified in this byte are sent. On reception of a telegram the gateway enters the number of characters received.

7.5 Swap word

When "Swap word" is activated, the data is exchanged word by word to and from the fieldbus. I.e. High and low bytes in a 16 bit word are exchanged and transferred to the CAN bus. It affects the entire fieldbus buffer.

8 Hardware ports, switches and LEDs CANopen (Mapping)

8.1 Device labeling

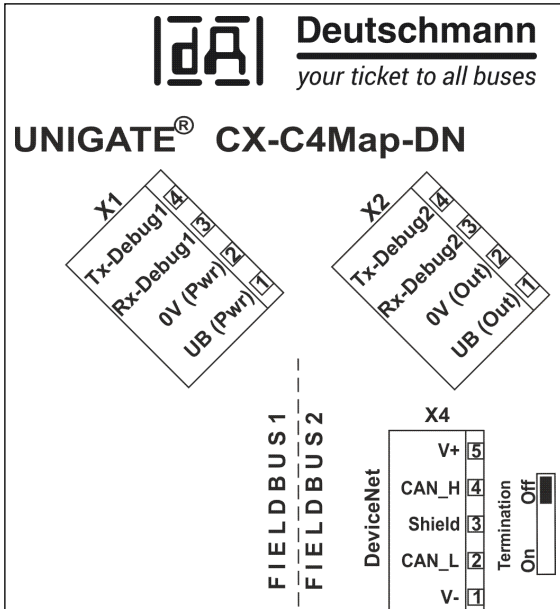

Picture 1. Terminal labeling and termination

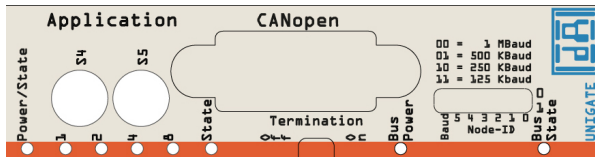

Picture 2: Front panel: Rotary switches, LEDs and termination CO



In case the front panel should pop out it does not affect the device's function or quality. It can be put in again without problems.

8.2 Connectors

8.2.1 Connector to the external device (RS-interface)

The service RS232 interface is available on the plug concealed on the top of the device.

Pin assignment (3-pin screw-type plug connector)

Pin No.	Name	Function
1	Rx 232	Receive signal
2	Tx 232	Transmit signal
3	AP-GND	Application Ground

8.2.2 Connector supply voltage and DEBUG-interface

Pin assignment X1 (4-pin screw-plug connector, on the bottom side, at the back)

Pin No.	Name	Function
1	UB (Pwr)	10..33 V supply voltage / DC
2	0 V (Pwr)	0 V supply voltage / DC
3	Rx-Debug	Receive signal Debug
4	Tx-Debug	Transmit signal Debug



Attention:

The ground for the DEBUG interface is pin 2, 0V (Pwr).

8.2.3 CANopen®-connector

The plug (labeled: CANopen®) for the connection to CANopen® is available on the front side of the device.

Pin assignment (9-pin D-SUB, plug)

Pin No.	Name	Function
1		
2	CAN-L	Dominant Low
3	CAN-GND	CAN Ground
4		
5		
6		
7	CAH-H	Dominant High
8		
9		

8.2.4 Power supply

The device must be powered with 10-33 VDC, The voltage supply is made through the 4-pole screw-plug connector at the device's bottom side.

Please note that the devices of the series UNIGATE® should not be operated with AC voltage.

8.3 LEDs

The Gateway UNIGATE® CL - CANopen® features 8 LEDs with the following significance:

LED (Bus) Power	green	Supply voltage CANopen®
LED (Bus) State	red/green	Interface state CANopen®
LED Power	green	Supply voltage serial interface
LED State	red/green	User-defined / general Gateway error
LEDs 1 / 2 / 4 / 8 (Error No. / Select ID)	green	User-defined / general Gateway error

8.3.1 LED “(Bus) Power“

This LED is connected directly to the electrically isolated supply voltage of the CANopen®-side.

8.3.2 LED “(Bus) State“

Indicator states and flash rates

The following Indicator states are distinguished:

LED on	constantly on
LED off	constantly off
LED flickering	iso-phase on and off with a frequency of approximately 10 Hz: on for approximately 50 ms and off for approximately 50 ms.
LED blinking	iso-phase on and off with a frequency of approximately 2,5 Hz: on for approximately 200 ms followed by off for approximately 200 ms.
LED single flash	one short flash (approximately 200ms) followed by a long off phase (approximately 1000 ms).
LED double flash	a sequence of two short flashes (approximately 200ms), separated by an off phase (approximately 200ms). The sequence is finished by a long off phase (approximately 1000 ms).
LED triple flash	a sequence of three short flashes (approximately 200ms), separated by an off phase (approximately 200ms). The sequence is finished by a long off phase (approximately 1000 ms).

If one bicolor Status LED is used instead of two single color LEDs, this LED shall indicate both the physical bus status and the status of the CANopen® state machine. This bicolor LED shall be red and green.

CANopen® ERROR LED (red)

The CANopen® Error LED indicates the status of the CAN physical layer and indicates errors due to missing CAN messages (SYNC, GUARD or HEARTBEAT).

ERROR LED	State	Description
Off	No error	The Device is in working condition.
Single flash	Warning limit reached	At least one of the error counters of the CAN controller has reached or exceeded the warning level (too many error frames).
Flickering	AutoBaud/LSS	Auto Baudrate detection in progress or LSS services in progress (alternately flickering with RUN LED).
Double flash	Error Control Event	A guard event (NMT-Slave or NMT-master) or a heartbeat event (Heartbeat consumer) has occurred.
Triple flash	Sync Error	The SYNC message has not been received within the configured communication cycle period time out (see Object Dictionary Entry 0x1006).
On	Bus Off	The CAN controller is'bus off

If at a given time several errors are present, the error with the highest number is indicated (e.g. if NMT Error and Sync Error occur, the SYNC error is indicated).

CANopen® RUN LED (green)

The CANopen® RUN LED indicates the status of the CANopen® network state machine.

CAN RUN LED	State	Description
Flickering	AutoBaud/LSS	Auto Baudrate detection in progress or LSS services in progress (alternately flickering with RUN LED).
Single flash	STOPPED	The device is in STOPPED state.
Blinking	PRE-OPERATIONAL	The device is in the PRE-OPERATIONAL state.
On	OPERATIONAL	The device is in the OPERATIONAL state.

Whilst the device is executing a reset the CANopen® RUN LED shall be off.

In case there is a conflict between turning the LED on green versus red, the LED may be turned on red. Apart from this situation, the bicolor status LED shall combine the behavior of the CAN Error LED.

8.3.3 LED “Power“

This LED is connected directly to the (optionally also electrically isolated) supply voltage of the serial interface (RS232/422/485).

8.3.4 LED “State“

Lights green	Data exchange active
Flashes green	Connection ok but no constant data exchange
Flashes green/red	No data exchange since switching on
Lights red	general gateway error (see LED's Error No.)
Flashes red	UNIGATE is in configuration / test mode

8.3.5 LEDs 1 / 2 / 4 / 8 (Error No / Select ID)

If these 4 LEDs flash and LED “State“ simultaneously lights red, the error number is displayed in binary notation (conversion table, see Annex) in accordance with the table in chapter "Error handling". Additionally there LEDs are controllable via Script.

8.4 Switches

The Gateway features 4 switches with the following functions:

Rotary coding switch S4	ID High for serial interface i. e. configmode
Rotary coding switch S5	ID Low for serial interface i. e. configmode
Termination (CANopen®)	switchable CANopen®-terminating resistor
DIP-switch	Node-ID and baud rate

8.4.1 Rotary coding switches S4 + S5 (serial interface)

This value is read in when the gateway is switched on.

8.4.2 Termination (CANopen®)

If the Gateway is operated as the first or last physical device in the CANopen®, there must be a bus termination at this Gateway. In order to do this, either a bus terminating resistor must be activated in the connector or the resistor (220 Ω) integrated in the Gateway must be activated. In order to do this, slide the slide switch to position ON. In all other cases, the slide switch must remain in position OFF. Please refer to the general Fieldbus literature for further information on the subject of bus termination.

Note: To activate or deactivate the bus termination, please remove the BUS-connector and carefully set the switch to the desired position.

8.4.3 DIP-Switch

The DIP-switch is used to set the Node-ID and Baud rate according to picture 3.

If the Node-ID 0 (which is not allowed in CANopen®) is set on the DIP-Switch, then the Node-ID, which is stored in the EEROM via the Script or WINGATE is used in this case. That way it is also possible to set Node-IDs > 63 and there is no unclarity if the Node-ID of the DIP-Switch or the Node-ID of the Script is valid.

In the initial state the Node-ID 1 is stored in the EEROM.

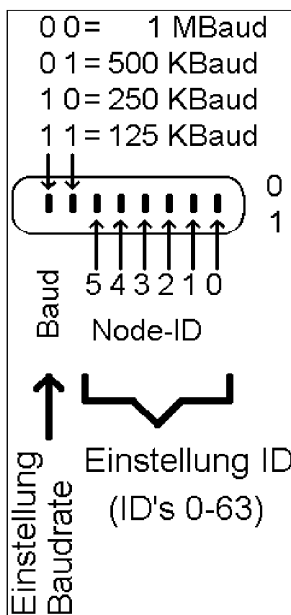

Picture 1: DIP-Switch

8.5 Debug cable for UNIGATE® CL

As accessory a pre-configured Debug cable is available. The Debug cable connects the Gateway to Debug and RS.

9 Hardware ports, switches and LEDs DeviceNet

9.1 Device labeling

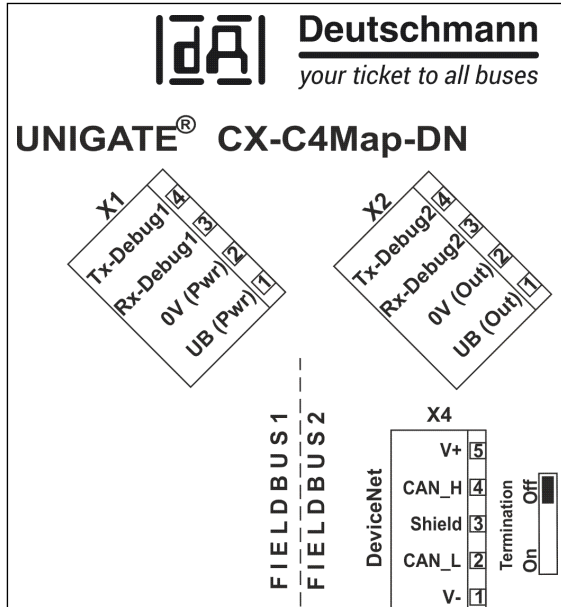

Picture 1: Terminal labeling and termination

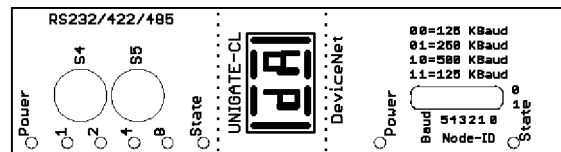

Picture 2: Front panel: Rotary switches, DIP-Switch and LEDs



In case the front panel should pop out it does not affect the device's function or quality. It can be put in again without problems.

9.1.1 Connectors

9.1.1.1 Connector service interface

The service RS232 interface is available on the plug concealed on the top of the device.

Pin assignment (3-pin screw-type plug connector)

Pin No.	Name	Function
1	Rx 232	Receive signal
2	Tx 232	Transmit signal
3	AP-GND	Application Ground

9.1.1.2 Connector supply voltage and DEBUG-interface

Pin assignment X2 (4-pole screw-plug connector, on the bottom side, at the back)

Pin No.	Name	Function
1	UB (Out)	10..33 V supply voltage / DC
2	0 V (Out)	0 V supply voltage / DC
3	Rx-Debug	Receive signal Debug
4	Tx-Debug	Transmit signal Debug



Attention:

The ground for the DEBUG interface is 0V (Pwr).

9.1.1.3 DeviceNet-connector

The plug (labeled: DeviceNet) for the connection to DeviceNet is available on the lower side of the device.

Pin assignment X3 (5-pole screw-plug connector)

Pin No.	Name	Function
1	V-	Supply voltage DeviceNet 0 V
2	CAN-L	Dominant Low
3	Shield	Cable shield
4	CAN-H	Dominant High
5	V+	Supply voltage DeviceNet 24 V

9.1.1.4 Power supply

The device must be powered with 10-33 VDC, The voltage supply is made through the 4-pole screw-plug connector at the device's bottom side.

Please note that the devices of the series UNIGATE® should not be operated with AC voltage.

9.2 LEDs

The Gateway UNIGATE® CL - DeviceNet features 8 LEDs with the following significance:

LED (Bus) Power	green	Supply voltage DeviceNet
LED (Bus) State	red/green	Interface state DeviceNet
LED Power	green	Supply voltage serial interface
LED State	red/green	User-defined / general Gateway error
LEDs 1 / 2 / 4 / 8 (Error No. / Select ID)	green	User-defined / general Gateway error

9.2.1 LED "(Bus) Power"

This LED is connected directly to the electrically isolated supply voltage of the DeviceNet-side.

9.2.2 LED "(Bus) State"

This LED operates as combined "Module/Network Status LED" according to DeviceNet-Specification.

Lights green	Gateway connected to master
Blinks green	No connection to DeviceNet-master
Blinks red	Errors that can be removed (e. g. Timeout)
Lights red	Serious error (e. g. double MAC-ID)
Blinks red/green	Communication error

9.2.3 LED "Power"

This LED is connected directly to the (optionally also electrically isolated) supply voltage of the serial interface (RS232/422/485).

9.2.4 LED "State"

Lights green	Data exchange active
Flashes green	Connection ok but no constant data exchange
Flashes green/red	No data exchange since switching on
Lights red	General Gateway error (see LEDs Error No.)
Flashes red	UNIGATE is in the configuration / test mode

9.2.5 LEDs 1 / 2 / 4 / 8 (Error No. / Select ID)

If these 4 LEDs flash and LED "State" simultaneously lights red, the error number is displayed in binary notation (conversion table, see Annex) in accordance with the table in chapter "Error handling". Additionally there LEDs are controllable via Script.

9.3 Switches

The Gateway features 4 switches with the following functions:

Rotary coding switch S4	ID High for serial interface i. e. configmode
Rotary coding switch S5	ID Low for serial interface i. e. configmode
Termination (DeviceNet)	switchable DeviceNet-terminating resistor
DIP-Switch	Node-ID and baud rate

9.3.1 Rotary coding switches S4 + S5 (serial interface)

These two switches can be read out through the Script command "Get (RS_Switch, Destination)" and the value can be used for further functions. This value is read in when the Gateway is switched on or always after a Script command has been executed. The switch positions "EE" (testmode) and "FF" (config mode) are not possible for RS422- or RS485-operation.

Note: The switch position "DD" (ie, S4 and S5 in position "D") is reserved for internal purposes.

9.3.2 Termination (DeviceNet)

If the Gateway is operated as the first or last physical device in the DeviceNet, there must be a bus termination at this Gateway. In order to do this, either a bus terminating resistor must be activated in the connector or the resistor (220 Ω) integrated in the Gateway must be activated. In order to do this, slide the slide switch to position ON. In all other cases, the slide switch must remain in position OFF. Please refer to the general Fieldbus literature for further information on the subject of bus termination.

9.3.3 DIP-switch

The DIP-switch is used to set the Node-ID and baud rate according to picture 3.

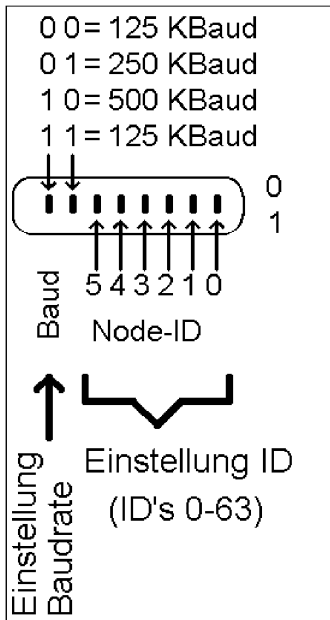

Picture 1: DIP-switch

9.4 The Debug cable for UNIGATE® CL

As accessory a pre-configured Debug cable is available. The Debug cable connects the Gateway to Debug and RS.

10 Error handling

10.1 Error handling at UNIGATE® C4Map

If the Gateway detects an error, the error is signalled by the "State" LED lighting red and, simultaneously, the error number being indicated by means of LEDs "Error No." as shown in the table below. A distinction can be made between two error categories:

Serious errors (1-5): In this case, the Gateway must be switched off and switched back on again. If the error occurs again, the Gateway must be exchanged and returned for repair.

Warnings (6-15): These warnings are displayed for one minute simply for information purposes and are then automatically reset. If such warnings occur frequently, please inform After-Sales Service.

For user-defined errors the flash frequency is 0.5 hertz. The error is displayed as long as defined by "Set Warning Time".

In the configuration mode these displays are not valid and only meant for internal use.

LED8	LED4	LED2	LED1	Error no. resp. ID	Error description system error (2x/sec)
0	0	0	0	0	Reserved
0	0	0	1	1	Hardware fault
0	0	1	0	2	EEROM error
0	0	1	1	3	Internal memory error
0	1	0	0	4	Fieldbus hardware error or wrong Fieldbus-ID
0	1	0	1	5	Script error
0	1	1	0	6	Reserved
0	1	1	1	7	RS-transmit buffer overflow
1	0	0	0	8	RS-receive buffer overflow
1	0	0	1	9	RS timeout
1	0	1	0	10	General fieldbus error
1	0	1	1	11	Parity-or frame-check-error
1	1	0	0	12	Reserved
1	1	0	1	13	Fieldbus configuration error
1	1	1	0	14	Fieldbus data buffer overflow
1	1	1	1	15	Reserved

Table 1: Error handling at UNIGATE® C4Map

10.2 Error handling at UNIGATE® CL-DeviceNet

If the Gateway detects an error, the error is signalled by the "State" LED lighting red and, simultaneously, the error number being indicated by means of LEDs "Error No." as shown in the table below. A distinction can be made between two error categories:

Serious errors (1-5): In this case, the Gateway must be switched off and switched back on again. If the error occurs again, the Gateway must be exchanged and returned for repair.

Warnings (6-15): These warnings are displayed for one minute simply for information purposes and are then automatically reset. If such warnings occur frequently, please inform After-Sales Service.

For user-defined errors the flash frequency is 0.5 hertz. The error is displayed as long as defined by "Set Warning Time".

In the configuration mode these displays are not valid and only meant for internal use. Tabelle 1:

LED8	LED4	LED2	LED1	Error no. resp. ID	Error description
0	0	0	0	0	Reserved
0	0	0	1	1	Hardware fault
0	0	1	0	2	EEROM error
0	0	1	1	3	Internal memory error
0	1	0	0	4	Fieldbus hardware error or wrong Fieldbus-ID
0	1	0	1	5	Script error
0	1	1	0	6	Reserved
0	1	1	1	7	RS-transmit buffer overflow
1	0	0	0	8	RS-receive buffer overflow
1	0	0	1	9	RS timeout
1	0	1	0	10	General fieldbus error
1	0	1	1	11	Parity-or frame-check-error
1	1	0	0	12	Reserved
1	1	0	1	13	Fieldbus configuration error
1	1	1	0	14	Fieldbus data buffer overflow
1	1	1	1	15	Reserved

Table 1: Error handling at UNIGATE® CL-DeviceNet - system error

11 Installation guidelines

11.1 Installation of the module

The module with the dimensions 23 x 117 x 111 mm resp. 23 x 117 x 117 mm with Option I/O8 (W x D x H) has been developed for switch cabinet use (IP 20) and can thus be mounted only on a standard mounting channel (deep DIN-rail to EN 50022).

11.1.1 Mounting

- Engage the module from the top in the top-hat rail and swivel it down so that the module engages in position.
- Other modules may be rowed up to the left and right of the module.
- There must be at least 5 cm clearance for heat dissipation above and below the module.
- The standard mounting channel must be connected to the equipotential bonding strip of the switch cabinet. The connection wire must feature a cross-section of at least 10 mm².

11.1.2 Removal

- First disconnect the power supply and signal lines.
- Then push the module up and swivel it out of the top-hat rail.

Vertical installation

The standard mounting channel may also be mounted vertically so that the module is mounted turned through 90°.

11.2 Wiring

11.2.1 Connection systems - DeviceNet

The following connection systems must resp. may be used when wiring the module:

- Standard screw-type/plug connection (power supply + Debug)
 - Standard screw-type/plug connection (DeviceNet)
- a) In the case of standard screw-type terminals, one lead can be clamped per connection point. It is best to then use a screwdriver with a blade width of 3.5 mm to firmly tighten the screw.

Permitted cross-sections of the line:

- Flexible line with wire-end ferrule: 1 x 0.25 ... 1.5 mm²
- Solid conductor: 1 x 0.25 ... 1.5 mm²
- Tightening torque: 0.5 ... 0.8 Nm

b) The plug-in connection terminal strip is a combination of standard screw-type terminal and plug connector. The plug connection section is coded and can thus not be plugged on the wrong way round.

c) The 9-pin D-SUB plug connector is secured with two screws with "4-40-UNC" thread. It is best to use a screwdriver with a blade width of 3.5 mm to screw the screw tight.

Tightening torque: 0.2... 0.4 Nm

11.2.2 Connection systems - CANopen

The following connection systems must resp. may be used when wiring the module:

- Standard screw-type/plug connection (power supply + Debug)

- 9-pin D-SUB plug connector (CANopen®)

a) In the case of standard screw-type terminals, one lead can be clamped per connection point. It is best to then use a screwdriver with a blade width of 3.5 mm to firmly tighten the screw.

Permitted cross-sections of the line:

- Flexible line with wire-end ferrule: 1 x 0.25 ... 1.5 mm²
- Solid conductor: 1 x 0.25 ... 1.5 mm²
- Tightening torque: 0.5 ... 0.8 Nm

b) The plug-in connection terminal strip is a combination of standard screw-type terminal and plug connector. The plug connection section is coded and can thus not be plugged on the wrong way round.

c) The 9-pin D-SUB plug connector is secured with two screws with "4-40-UNC" thread. It is best to use a screwdriver with a blade width of 3.5 mm to screw the screw tight.

Tightening torque: 0.2... 0.4 Nm

11.2.2.1 Power supply

The device must be powered with 10..33 V DC.

- Connect the supply voltage to the 4-pole plug-in screw terminal in accordance with the labeling on the device.

11.2.2.2 Equipotential bonding connection

The connection to the potential equalization automatically takes place if it is put on the DIN-rail.

12 CANopen® communication interface

12.1 Bus line with copper cable

This interface is located on the module in the form of a 9-pin D-SUB plug on the front side of the housing.

- Plug the CANopen® connector onto the SUB-D plug labelled "CANopen®".
- Firmly screw the securing screws of the plug connector tight using a screwdriver.
- If the module is located at the start or end of the CANopen® line, you must connect the bus terminating resistor integrated in the gateway. In order to do this, slide the slide switch to the position labeled ...on...
 - If the module is not located at the start or at the end, you must set the slide switch to position "off".

12.2 Line routing, shield and measures to combat interference voltage

This chapter deals with line routing in the case of bus, signal and power supply lines, with the aim of ensuring an EMC-compliant design of your system.

12.3 General information on line routing

Inside and outside of cabinets

In order to achieve EMC-compliant routing of the lines, it is advisable to split the lines into the following line groups and to lay these groups separately.

- ⇒ Group A:
 - shielded bus and data lines (e. g. for PROFIBUS DP, RS232C and printers etc.)
 - shielded analogue lines
 - unshielded lines for DC voltages ≥ 60 V
 - unshielded lines for AC voltage ≥ 25 V
 - coaxial lines for monitors
- ⇒ Group B:
 - unshielded lines for DC voltages ≥ 60 V and ≥ 400 V
 - unshielded lines for AC voltage ≥ 24 V and ≥ 400 V
- ⇒ Group C:
 - unshielded lines for DC voltages > 400 V

The table below allows you to read off the conditions for laying the line groups on the basis of the combination of the individual groups.

	Group A	Group B	Group C
Group A	1	2	3
Group B	2	1	3
Group C	3	3	1

Table 3: Line laying instructions as a function of the combination of line groups

- 1) Lines may be laid in common bunches or cable ducts.

- 2) Lines must be laid in separate bunches or cable ducts (without minimum clearance).
- 3) Lines must be laid in separate bunches or cable ducts inside cabinets but on separate cable racks with at least 10 cm clearance outside of cabinets but inside buildings.

12.3.1 Shielding of lines

Shielding is intended to weaken (attenuate) magnetic, electrical or electromagnetic interference fields.

Interference currents on cable shields are discharged to earth via the shielding bus which is connected conductively to the chassis or housing. A low-impedance connection to the PE wire is particularly important in order to prevent these interference currents themselves becoming an interference source.

Wherever possible, use only lines with braided shield. The coverage density of the shield should exceed 80%. Avoid lines with foil shield since the foil can be damaged very easily as the result of tensile and compressive stress on attachment. The consequence is a reduction in the shielding effect.

In general, you should always connect the shields of cables at both ends. The only way of achieving good interference suppression in the higher frequency band is by connecting the shields at both ends.

The shield may also be connected at one end only in exceptional cases. However, this then achieves only an attenuation of the lower frequencies. Connecting the shield at one end may be more favorable if

- it is not possible to lay an equipotential bonding line
- analogue signals (a few mV resp. mA) are to be transmitted
- foil shields (static shields) are used.

In the case of data lines for serial couplings, always use metallic or metallized plugs and connectors. Attach the shield of the data line to the plug or connector housing.

If there are potential differences between the earthing points, a compensating current may flow via the shield connected at both ends. In this case, you should lay an additional equipotential bonding line.

Please note the following points when shielding:

- Use metal cable clips to secure the shield braiding. The clips must surround the shield over a large area and must have good contact.
- Downstream of the entry point of the line into the cabinet, connect the shield to a shielding bus. Continue the shield as far as the module, but do not connect it again at this point!

13 CANopen®

13.1 Description CANopen®

This specification is based on the CiA® Draft Standard 301 (DS301).

CANopen® supports the Standard CAN-frame with 11-bit Identifier.

It is not required to support the extended frame with 29-bit Identifier.

Benutzen Sie folgende Werte als Parameter:

Parameter	Type	Meaning
vw_Channel	Word	Value Meaning
		0 Using CAN Layer2, we have no PDO and SDO data access
		1..8 Define PDO 1..8
Direction	-	RX or Tx depending of the data direction. It is seen from the devices view, this means Rx-data is incoming data.
vw_ByteLen	Byte	Length of the object to use. If the length is > 8 byte only the first 8 bytes are used to transmit by the PDO
vw_ObjAddress	Word	Allowed values are 0x2000 to 0x5FFF, which is the range of objects to be defined by the user
vw_COB_ID	Word	Value Meaning
		0 PDO is not active, data is defined to be used by a SDO transfer only.
		0x181..0x57F Allowed range for normal Rx and Tx - PDO's
		0xFFFFE Is to be used, if the master defines the COB-ID's when the CANopen network is started by the master (no predefined COB-IDs). The resulting objects used by the device are 0x1800 + (PDO-Nr - 1). Sub-Index 1 of this object contains the COB-ID. After writing a valid value to this object with subindex the requested PDO becomes active. Valid values must be in the range from 0x181 to 0x57F.
		0xFFFF Is to be used for PDO1 and PDO2. The COB-ID is as defined by the predefined connection set Tx-PDO1: 0x180 + Node-ID Rx-PDO1: 0x200 + Node-ID Tx-PDO2: 0x280 + Node-ID Rx-PDO2: 0x300 + Node-ID

13.1.1 CANopen® V4

Additional supported functions:

- Heartbeat
- Dynamic mapping
- Onswitch message

The following example can be found in the file folder "example" after the installation of the software "Protocol Developer" (this example gives a detailed description of the initialization):

- Example_CO_V4.dss

At CANopen® V4 the following fieldbus-specific Scripts are supported:

- Init Object Table
- Create Object
- Set PDO Communication
- Set PDO Mapping
- Write Object
- Read New CANopen® Object Data
- Emergency Message

The software does not support default objects, as at CANopen® V3.

14 Communication interface DeviceNet

14.1 Bus line with copper cable

This interface is located on the module in the form of a 5-pin screw-plug-connector on the lower side of the housing.

- Plug the DeviceNet connecting plug onto the socket labelled "DeviceNet".
- If the module is located at the start or end of the DeviceNet line, you must switch on the bus terminating resistor integrated in the gateway. In order to do this, slide the sliding switch to the position labelled ...on...
- If the module is not located at the start or at the end, you must set the sliding switch to position "off".

14.2 Line routing, shield and measures to combat interference voltage

This chapter deals with line routing in the case of bus, signal and power supply lines, with the aim of ensuring an EMC-compliant design of your system.

14.2.1 General information on line routing

- Inside and outside of cabinets

In order to achieve EMC-compliant routing of the lines, it is advisable to split the lines into the following line groups and to lay these groups separately.

- ⇒ Group A:
 - shielded bus and data lines (e. g. for ProfibusDP, RS232C and printers etc.)
 - shielded analogue lines
 - unshielded lines for DC voltages ≥ 60 V
 - unshielded lines for AC voltage ≥ 25 V
 - coaxial lines for monitors
- ⇒ Group B:
 - unshielded lines for DC voltages ≥ 60 V and ≥ 400 V
 - unshielded lines for AC voltage ≥ 24 V and ≥ 400 V
- ⇒ Group C:
 - unshielded lines for DC voltages > 400 V

The table below allows you to read off the conditions for laying the line groups on the basis of the combination of the individual groups.

	Group A	Group B	Group C
Group A	1	2	3
Group B	2	1	3
Group C	3	3	1

Table 3: Line laying instructions as a function of the combination of line groups

- 1) Lines may be laid in common bunches or cable ducts.
- 2) Lines must be laid in separate bunches or cable ducts (without minimum clearance).
- 3) Lines must be laid in separate bunches or cable ducts inside cabinets but on separate cable racks with at least 10 cm clearance outside of cabinets but inside buildings.

14.2.1.1 Shielding of lines

Shielding is intended to weaken (attenuate) magnetic, electrical or electromagnetic interference fields.

Interference currents on cable shields are discharged to earth via the shielding bus which is connected conductively to the chassis or housing. A low-impedance connection to the PE wire is particularly important in order to prevent these interference currents themselves becoming an interference source.

Whenever possible, use only lines with braided shield. The coverage density of the shield should exceed 80%. Avoid lines with foil shield since the foil can be damaged very easily as the result of tensile and compressive stress on attachment. The consequence is a reduction in the shielding effect.

In general, you should always connect the shields of cables at both ends. The only way of achieving good interference suppression in the higher frequency band is by connecting the shields at both ends.

The shield may also be connected at one end only in exceptional cases. However, this then achieves only an attenuation of the lower frequencies. Connecting the shield at one end may be more favorable if

- it is not possible to lay an equipotential bonding line
- analogue signals (a few mV resp. mA) are to be transmitted
- foil shields (static shields) are used.

In the case of data lines for serial couplings, always use metallic or metallized plugs and connectors. Attach the shield of the data line to the plug or connector housing.

If there are potential differences between the earthing points, a compensating current may flow via the shield connected at both ends. In this case, you should lay an additional equipotential bonding line.

Please note the following points when shielding:

- Use metal cable clips to secure the shield braiding. The clips must surround the shield over a large area and must have good contact.
- Downstream of the entry point of the line into the cabinet, connect the shield to a shielding bus. Continue the shield as far as the module, but do not connect it again at this point!

15 DeviceNet

15.1 The Product Code

The device's Product Code is an unsigned integer value (UINT) with values ranging between 0 and 65535 and it is included in the first instance (01 hex) of the Identity Object (01 hex) in attribute 3 (0003 hex).

15.2 EDS file

In order to use a device with the set values in a DeviceNet network, a corresponding EDS file has to be integrated into the configuration tool.

Below you find a sample EDS file. The file (CLDN.eds) can also be downloaded from our website www.deutschmann.com.

15.3 DeviceNet™ information

General information

In the DeviceNet network the UNIGATE® RS-DeviceNet operates as a Class 2 Slave. The device supports Poll connections, Change-Of-State messages and Bit Strobe of the predefined master Slave Connection Set. The device does not support "Explicit Unconnected Message Manager" (UCMM).

The device purely supports all combinations of Consumed Size and Produced Size between 1 and 255 bytes. The sizes can be chosen as desired.

Message Types

As group 2 slaves, the device supports the following message types.

CAN Identifier	Group 2 Message Type
10xxxxxx111	Duplicate MAC ID Check Message
10xxxxxx110	Unconnected Explicit Request Message
10xxxxxx101	Master I/O Poll Command Request
10xxxxxx100	Master Explicit Request Message

xxxxxx = Node Address

Class Services

As Group 2 Slave the UNIGATE® RS-DeviceNet supports the following class services and instance services.

Service Code (hex)	Group 2 Message Type
0E	Get Attribute Single
10	Set Attribute Single
4B	Allocate predefined master slave Connection Set
4C	Release predefined master slave Connection Set

Object Classes

The UNIGATE® RS-DeviceNet the following object classes.

Class (hex)	Group 2 Message Type
01	Identity
03	DeviceNet
05	Connection
64	Consumed Data
65	Produced Data

16 Technical data

16.1 Device data

The technical data of the module is given in the table below.

No.	Parameter	Data	Explanations
1	Location	Switch cabinet	DIN-rail mounting
2	Enclosure	IP20	Protection against foreign bodies and water to IEC 529 (DIN 40050)
3	Service life	10 years	
4	Housing size	23 x 115 x 116 mm (screw-plug-connector included) 23 x 115 x 100 mm (screw-plug connector not included)	W x D x H
5	Installation position	Any	
6	Weight	240 g	
7	Operating temperature	-40°C ... +85°C	
8	Storage/transport temperature	-40 °C ... +85 °C	
9	Atmospheric pressure during operation during transport	795 hPa ... 1080 hPa 660 hPa ... 1080 hPa	
10	Installation altitude	2000 m 4000 m	Unrestricted Restricted - Ambient temperature ≤ 40°C
11	Relative humidity	Max. 80 %	No condensation, no corrosive atmosphere
12	External power supply	10..33 V DC	Standard power supply unit to DIN 19240
13	Current consumption at 24 VDC	Typ. 76 mA max 93 mA	At 10V. typ. 80 mA
14	Reverse voltage protection	Yes	But does not function!
15	Short-circuit protection	Yes	
16	Overload protection	Poly-switch	Thermal fuse
17	Undervoltage detection (USP)	≤ 9 V DC	
18	Emergency power supply	≥ 5 ms	Device fully operable

Table: Technical data of the module

16.1.1 Interface data

The table below lists the technical data of the interfaces and ports on the device. The data has been taken from the corresponding Standards.

No.	Interface designation Physical interface	CANopen® RS485	RS232-C RS232-C	DeviceNet
1	Standard	CiA® DS 102	DIN 66020	CiA® DS 102
2	Transmission mode	Symmetrical asynchronous serial half-duplex → Difference signal	Asymmetrical asynchronous serial full duplex → Level	Symmetrical asynchronous serial half-duplex → Difference signal
3	Transmission method	Master / slave	Master / slave	Master / slave
4	Number of users : - Transmitters - Receivers	32 32	1 1	32 32
5	Cable length: - Maximum - Baud rate-dependent	1300 m 50 kBd → 1300 m 100 kBd → 640 m 200 kBd → 310 m 500 kBd → 112 m 1 MBd → 40 m	15 m no	500 m 125 kB → 500 m 250 kB → 250 m 500 kB → 100 m
6	Bus topology	Line	Point-to-point	Line
7	Data rate: - Maximum - Standard values	1MBit/s 125 kB 250 kB 500 kB 1 MB	120 kBit/s 2.4 k/B 4.8 k/B 9.6 kBit/s 19.2 kBit/s 38.4 kBit/s	500 kBit/s 125 kB 250 kB 500 kB
8	Transmitter: - Load - Maximum voltage - Signal, unloaded - Signal, loaded	54 Ω - 7 V ... 12 V ± 5 V ± 1.5 V	3 ... 7 kΩ ± 25 V ± 15 V ± 5 V	54 Ω - 7 V ... 12 V ± 5 V ± 1.5 V
9	Receiver: - Input resistance - Max. input signal - Sensitivity	12 Ω - 7 V ... 12 V ± 0.2 V	3 ... 7 Ω ± 15 V ± 3 V	12 Ω - 7 V ... 12 V ± 0.2 V
10	Transmit range (SPACE): - Voltage level - Logic level	- 0.5 ... + 0.05 V 0	+ 3 ... + 15 V 0	- 0.5 ... + 0.05 V 0
11	Transmit pause (MARK): - Voltage level - Logic level	+ 1.5 ... +3 V 1	- 3 ... -15 V 1	+ 1.5 ... +3 V 1

Table: Technical data of the interfaces and ports on the module

17 Commissioning guide

17.1 Note

Only trained personnel following the safety regulations may commission the UNIGATE®.

17.2 Components

You will require the following components to commission the UNIGATE®:

- UNIGATE®
- Connector for the CANopen connection to the gateway
- Connector for the DeviceNet connection to the gateway
- DeviceNet™ cable (this cable is generally already installed on site!)
- 10..33 V DC power supply (DIN 19240)
- Type file or EDS file and user manual (a sample file as well as the user manual can be ordered separately or downloaded free of charge from our homepage at www.deutschmann.de).

17.3 Installation

The UNIGATE® CX-C4Map-DN module features protection type IP20 and is thus suitable for switch cabinet use. The device is designed for snapping onto a 35 mm DIN-rail..

17.4 Dimensional drawing UNIGATE® CX-C4Map-DN

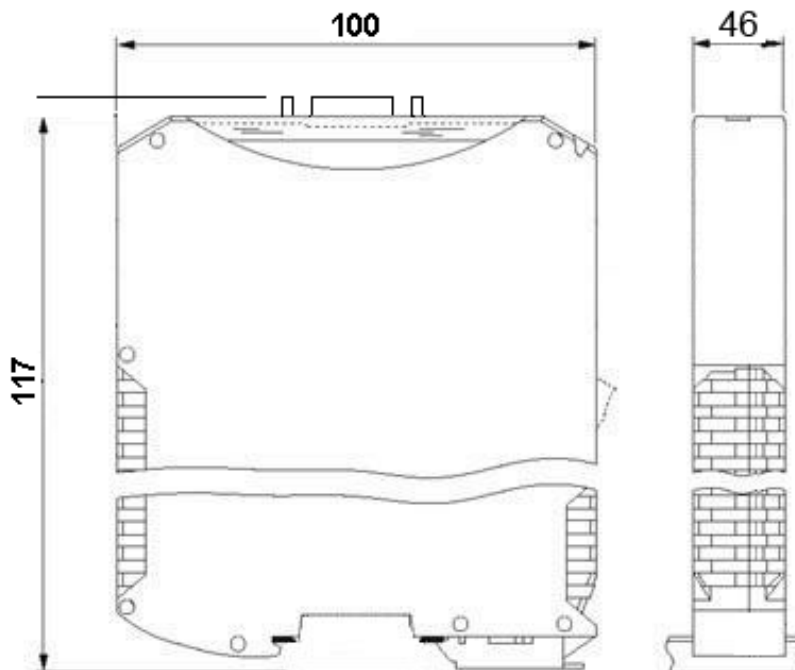

17.5 Commissioning

It is essential that you perform the following steps during commissioning in order to ensure that the module operates correctly:

17.6 Setting the CANopen® address and baud rate

Set the CANopen®-Node-ID and the baud rate at the fieldbus end of the module on the DIP-switch (see also chapter 27.4.3).



Attention:

The CANopen® address set must correspond to the planned address!
All users in the CANopen® have to use the same Baud rate!
These values are read in only on power-up of the gateway!

17.6.1 CANopen® connection

Connect the device to the CANopen® at the interface labelled "CANopen®".

17.6.2 Connection to the process device

Please also read the manual for the process device when commissioning the process device.

17.6.3 Connecting the supply voltage

Please connect 10..33 DC voltage to the terminals provided for this.

17.6.4 Shield connection

Earth the top-hat rail onto which the module has been snapped.

17.6.5 Project planning

Use any project planning tool for project planning.

If the required EDS file was not supplied with your project planning tool, a sample file can be found on the Internet (www.deutschmann.de).

17.7 Setting the DeviceNet™ address and baud rate

Set the DeviceNet-Node-ID and the baud rate at the fieldbus end of the module on the DIP-switch (see chapter 28.3.3).



Attention:

The DeviceNet address set must correspond to the planned address!
All users in the DeviceNet have to use the same Baud rate!
These values are read in only on power-up of the gateway!

17.8 DeviceNet™ connection

Connect the device to the DeviceNet at the interface labelled "DeviceNet".

17.9 Connection to the process device

Please also read the manual for the process device when commissioning the process device.

17.10 Connecting the supply voltage

Please connect 10..33 DC voltage to the terminals provided for this.

17.11 Shield connection

Earth the top-hat rail onto which the module has been snapped.

17.12 Project planning

Use any project planning tool for project planning.

If the required EDS file was not supplied with your project planning tool, you can find a sample file in chapter 34.2 or on the Internet at www.deutschmann.de.

18 Servicing

Should questions arise that are not covered in this manual you can find further information in our

- FAQ/Wiki area on our homepage www.deutschmann.com or directly in our Wiki on www.wiki.deutschmann.de

If your questions are still unanswered please contact us directly.

Please note down the following information before calling:

- Device designation
- Serial number (S/N)
- Article number
- Error number and error description

Your request will be recorded in the Support center and will be processed by our Support Team as quickly as possible (Usually in 1 working day, rarely more than 3 working days.).

The technical support hours:

Monday to Thursday from 8 am to midday and from 1 pm to 4 pm, Friday from 8 am to midday. (CET)

Deutschmann Automation GmbH & Co. KG
Carl-Zeiss-Straße 8
D-65520 Bad-Camberg
Germany

Central office and sales department +49 6434 9433-0
Technical support +49 6434 9433-33

Fax sales department +49 6434 9433-40
Fax technical support +49 6434 9433-44

E-mail technical support support@deutschmann.de

18.1 Returning a device

If you return a device, we require as comprehensive a fault/error description as possible. We require the following information in particular:

- What error number was displayed?
- What is the supply voltage (± 0.5 V) with Gateway connected?
- What were you last doing or what last happened on the device (programming, error on power-up,...)?

The more precise information a fault/error description you provide, the more exactly we will be able to pinpoint the possible causes.

18.2 Downloading PC software

You can download current information and software free of charge from our Internet server. <http://www.deutschmann.com>

19 Annex

19.1 Explanations of the abbreviations

General

CL	=	Product group CL (Compact Line)
CM	=	Product group CM (CANopen Line)
CX	=	Product group CX
EL	=	Product group EL (Ethernet Line)
FC	=	Product group FC (Fast Connect)
GT	=	Galvanic separation RS-side
GY	=	Housing color gray
MB	=	Product group MB
RS	=	Product group RS
SC	=	Product group SC (Script)
232/485	=	Interface RS232 and RS485 switchable
232/422	=	Interface RS232 and RS422 switchable
DB	=	Additional RS232 DEBUG-interface
D9	=	Connection of the RS through 9-pin D-SUB instead of 5-pin screw-plug connector
PL	=	Board only without DIN-rail module and without housing cover
PD	=	Board only without DIN-rail module and with housing cover
AG	=	Gateway installed in a die-cast aluminum housing
EG	=	Gateway installed in a stainless steel housing
IC	=	Product group IC (IC-design DIL32)
IC2	=	Product group IC2 (IC-design DIL32)
IO8	=	Option I/O8
16	=	Script memory expanded to 16KB
5V	=	Operating voltage 5V
3,3V	=	Operating voltage 3.3V

Fieldbus

CO	=	CANopen
C4	=	CANopen V4
C4X	=	CANopen V4-version X (see comparison table UNIGATE [®] IC for the respective product)
DN	=	DeviceNet
EC	=	EtherCAT
EI	=	Ethernet/IP
FE	=	Ethernet 10/100 MBit/s
FEX	=	Ethernet 10/100 MBit/s-version X (see comparison table UNIGATE [®] IC for the respective product)
IB	=	Interbus
IBL	=	Interbus
LN62	=	LONWorks62
LN512	=	LONWorks512
ModTCP	=	ModbusTCP
MPI	=	Siemens MPI [®]
PL	=	Powerlink
PN	=	Profinet-IO
PBDP	=	ProfibusDP
PBDPL	=	ProfibusDP-version L (see comparison table UNIGATE [®] IC for the respective product)

product)
PBDPX = ProfibusDP-version X (see comparison table UNIGATE[®] IC for the respective product)
PBDPV0 = ProfibusDPV0
PBDPV1 = ProfibusDPV1
RS = Serial RS232/485/422

19.2 Hexadecimal table

Hex	Decimal	Binary
0	0	0000
1	1	0001
2	2	0010
3	3	0011
4	4	0100
5	5	0101
6	6	0110
7	7	0111
8	8	1000
9	9	1001
A	10	1010
B	11	1011
C	12	1100
D	13	1101
E	14	1110
F	15	1111

