

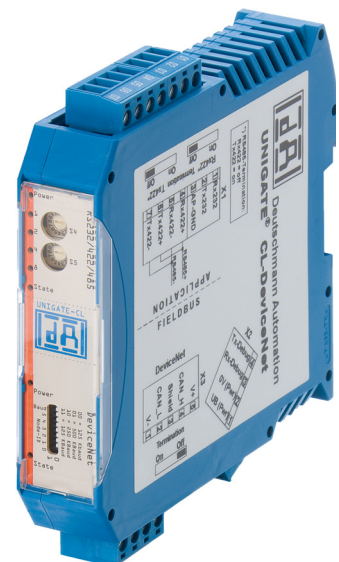

Deuschmann

your ticket to all buses

**Instruction Manual
Universal Fieldbus-Gateway
UNIGATE® CL - DeviceNet**



1	Information on CE marking of the module	8
1.1	EU Directive EMC	8
1.2	Scope of application	8
1.3	Note installation guidelines	8
1.4	Installation of the unit	8
1.5	Working on switch cabinets	8
2	Information for the machine manufacturers	9
2.1	Introduction	9
2.2	EU Machinery Directive	9
3	Introduction	10
3.1	UNIGATE® CL software flow-chart	11
3.2	UNIGATE® block diagram	12
3.3	UNIGATE® application diagram	12
4	Operation modes of the Gateway	13
4.1	Configuration mode (config mode)	13
4.2	Test mode	13
4.3	Data exchange mode	13
5	RS-interface	14
5.1	RS-interfaces at the UNIGATE® CL	14
5.2	Buffer sizes at the UNIGATE® CL	14
5.3	Framing Check	14
6	SSI-interface	15
6.1	Initiation of the SSI-interface	15
6.2	Hardware-wiring	16
7	The Debug-interface	17
7.1	Overview of the Debug-interface	17
7.2	Starting in the Debug-mode	17
7.3	Communication parameter for the Debug-interface	17
7.4	Possibilities with the Debug-interface	17
7.5	Commands of the Debug-interface	17
8	Mode of operation of the system	18
8.1	General explanation	18
8.2	Interfaces	18
8.3	Data exchange DeviceNet	18
8.3.1	Polling	18
8.4	Possible data lengths	18
9	Generating a Script	19
9.1	What is a Script?	19
9.2	Memory efficiency of the programs	19
9.3	What can you do with a Script device?	19
9.4	Independence of buses	19
9.5	Further settings at the Gateway	19
9.6	The use of the Protocol Developer	20
9.7	Accuracies of the baud rates	20
9.8	Script processing times	21

10	Implemented protocols in UNIGATE® CL with Universal Script	22
10.1	Protokoll: Transparent	22
10.1.1	Data structure.	22
10.2	Protocol: Universal 232	22
10.2.1	Data structure.	22
10.2.2	Fieldbus parameters	23
10.2.3	RS232 parameter table	23
10.2.4	Communication sequence	23
10.3	Protocol: 3964(R)	24
10.3.1	Data structure 3964R.	24
10.3.2	Protocol definitions	24
10.3.3	Data communication	24
10.3.4	Protocol type 3964	25
10.4	Protocol: MODBUS-RTU	25
10.4.1	Notes	25
10.4.2	UNIGATE as MODBUS-Master	25
10.4.3	UNIGATE® as MODBUS-Slave	26
10.4.4	UNIGATE® as Modbus-ASCII Master	27
10.5	The trigger byte	27
10.6	The length byte	27
11	Hardware ports, switches and LEDs	28
11.1	Device labeling	28
11.2	Connectors	28
11.2.1	Connector to the external device (RS-interface)	28
11.2.2	Connector supply voltage and DEBUG-interface.	29
11.2.3	DeviceNet-connector	29
11.2.4	Power supply	29
11.3	LEDs	29
11.3.1	LED "(Bus) Power"	29
11.3.2	LED "(Bus) State".	29
11.3.3	LED "Power"	30
11.3.4	LED "State"	30
11.3.5	LEDs 1 / 2 / 4 / 8 (Error No. / Select ID)	30
11.4	Switches	30
11.4.1	Termination Rx 422 + Tx 422 (serial interface).	30
11.4.2	Rotary coding switches S4 + S5 (serial interface)	30
11.4.3	Termination (DeviceNet)	31
11.4.4	DIP-switch	31
11.5	The Debug cable for UNIGATE® CL	31
12	Error handling	32
12.1	Error handling at UNIGATE® CL	32
13	Installation guidelines	33
13.1	Installation of the module	33
13.1.1	Mounting	33
13.1.2	Removal	33
13.2	Wiring	33
13.2.1	Connection systems	33

13.2.2	DeviceNet communication interface	34
13.2.3	Line routing, shield and measures to combat interference voltage	34
13.2.4	General information on line routing	34
14	DeviceNet	36
14.1	The Product Code	36
14.2	EDS file	36
14.2.1	Sample EDS file	36
14.3	DeviceNet™ information	38
15	Technical data	39
15.1	Device data	39
15.1.1	Interface data	40
16	Commissioning guide	41
16.1	Note	41
16.2	Components	41
16.3	Installation	41
16.4	Dimensional drawing UNIGATE® CL - DeviceNet™	41
16.5	Commissioning	41
16.6	Setting the DeviceNet™ address and baud rate	41
16.7	DeviceNet™ connection	42
16.8	Connection to the process device	42
16.9	Connecting the supply voltage	42
16.10	Shield connection	42
16.11	Project planning	42
17	Servicing	43
17.1	Returning a device	43
17.2	Downloading PC software	43
18	Annex.	44
18.1	Explanations of the abbreviations	44
18.2	Hexadecimal table	45

Disclaimer of liability

We have checked the contents of the document for conformity with the hardware and software described. Nevertheless, we are unable to preclude the possibility of deviations so that we are unable to assume warranty for full compliance. The information given in the publication is, however, reviewed regularly. Necessary amendments are incorporated in the following editions. We would be pleased to receive any improvement proposals which you may have.

Copyright

Copyright (C) Deutschmann Automation GmbH & Co. KG 1997 – 2017. All rights reserved. This document may not be passed on nor duplicated, nor may its contents be used or disclosed unless expressly permitted. Violations of this clause will necessarily lead to compensation in damages. All rights reserved, in particular rights of granting of patents or registration of utility-model patents.

1 Information on CE marking of the module

1.1 EU Directive EMC

The following applies to the module described in this User Manual:

Products which bear the CE mark comply with the requirements of EU Directive „Electromagnetic Compatibility“ and the harmonized European Standards (EN) listed therein.

The EU Declarations of Conformity are available at the following location for perusal by the responsible authorities in accordance with the EU Directive, Article 10:

Deutschmann Automation GmbH & Co. KG, Carl-Zeiss-Straße 8, 65520 Bad Camberg, Germany.

1.2 Scope of application

The modules are designed for use in the industrial sector and comply with the following requirements.

Scope of application	Requirement applicable to	
	Emitted interference	Interference immunity
Industry	EN 55011, cl. A (2007)	EN 61000-6-2 (2005)

1.3 Note installation guidelines

The module complies with the requirements if you

1. comply with the installation guidelines described in the User Manual when installing and operating the module.
2. also follow the rules below on installation of the equipment and on working on switch cabinets.

1.4 Installation of the unit

Modules must be installed in electrical equipment rooms/areas or in enclosed housings (e.g. switch boxes made of metal or plastic). Moreover, you must earth the unit and the switch box (metal box) or at least the top-hat rail (plastic box) onto which the module has been snapped.

1.5 Working on switch cabinets

In order to protect the modules against static electrical discharge, the personnel must discharge themselves electrostatically before opening switch cabinets or switch boxes.

2 Information for the machine manufacturers

2.1 Introduction

The UNIGATE® module does not constitute a machine as defined by the EU "Machinery" Directive. Consequently, the module does not have a Declaration of Conformity in relation to the EU Machinery Directive.

2.2 EU Machinery Directive

The EU Machinery Directive stipulates the requirements applicable to a machine. The term "machine" is taken to mean a totality of connected parts or fixtures (see also EN 292-1, Paragraph 3.1)

The module is a part of the electrical equipment of the machine and must thus be included by the machine manufacturer in the Declaration of Conformity process.

3 Introduction

The UNIGATE® CL-DeviceNet module serves to adapt a serial port to DeviceNet in accordance with "DeviceNet Specification Release 2.0". In this application, it functions as a Gateway and operates as DeviceNet "Group 2 Only Slave". It can be operated by any standard-compliant Master.

The module CL-DeviceNet essentially consists of the following hardware components:

- Electrically isolated interface to DeviceNet
- CAN-controller SJA 1000
- Microprocessor 89C51RD2
- RAM and EPROM
- Optionally electrically isolated RS-interface
- Serial interface (RS232, RS485 and RS422) to the device connected externally

3.1 UNIGATE® CL software flow-chart

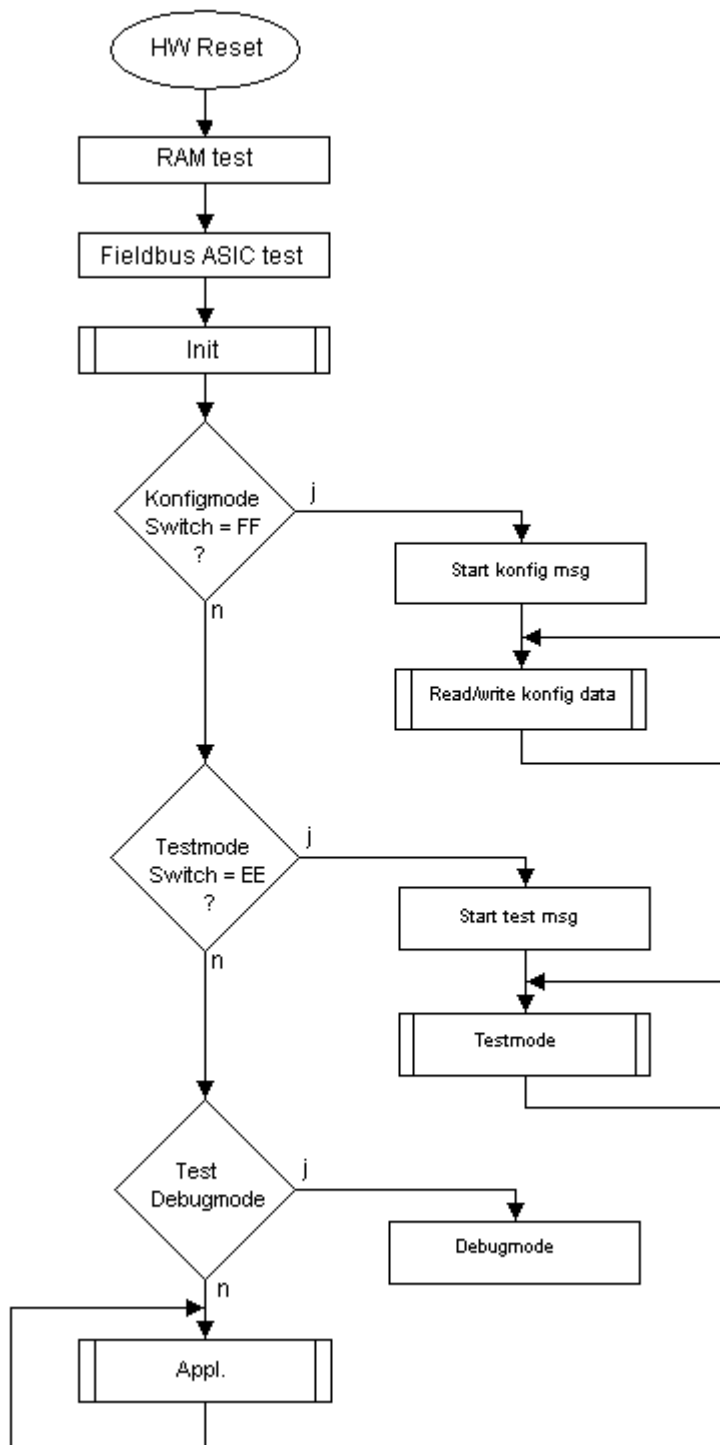

3.2 UNIGATE® block diagram

The following picture shows a typical UNIGATE®-module design.

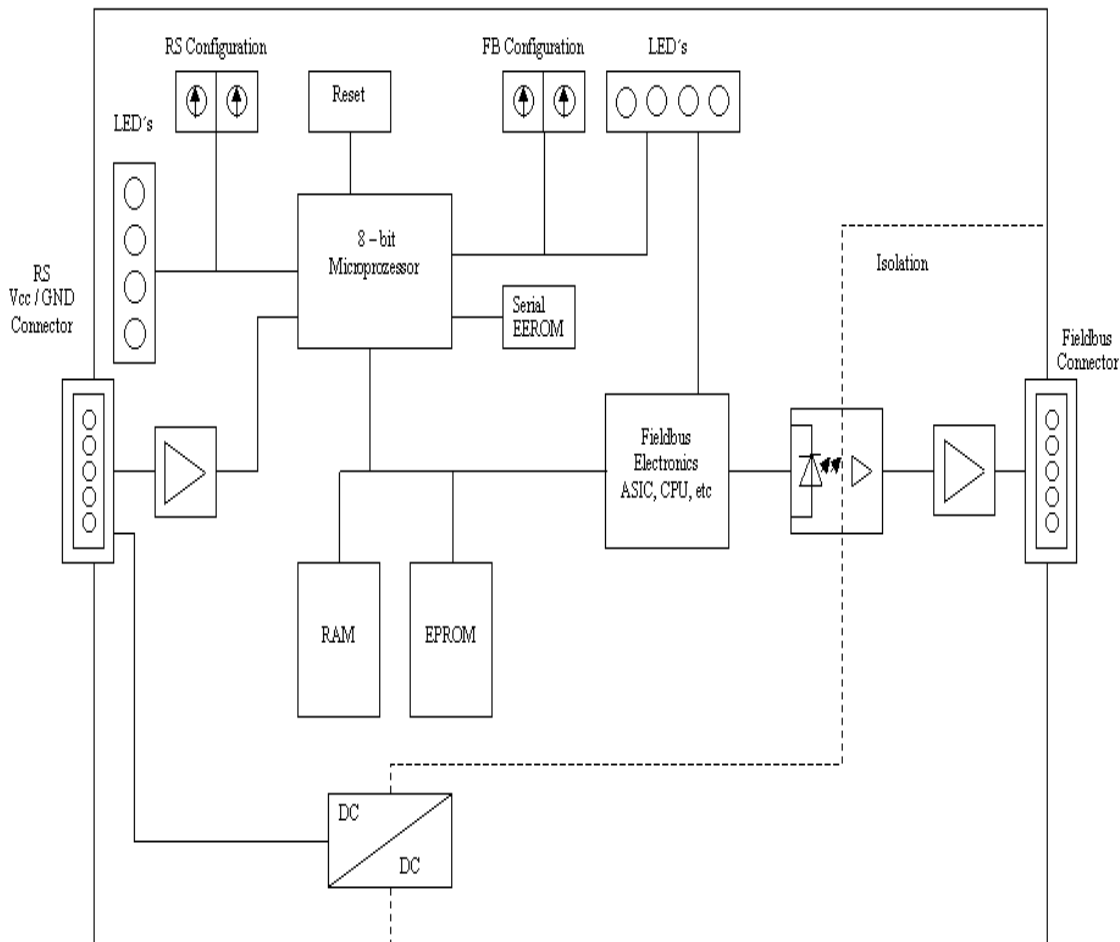

3.3 UNIGATE® application diagram

The following graph shows a typical connection scheme.

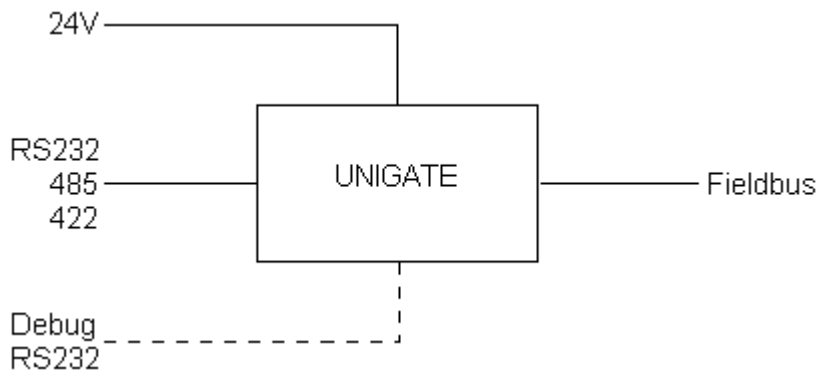

4 Operation modes of the Gateway

4.1 Configuration mode (config mode)

The configuration mode serves to configure the Gateway. The following adjustments are possible in this mode.

- Loading a Script
- Updating the firmware
- Configuring the Gateway

The Gateway will be starting in this mode in case both switches S4 as well as S5 are set on position "F" when switching on the Gateway. Right after switching on the Gateway in the configuration mode it will be sending its starting message, that looks analog with the following message: "RS-DN-CL (232/422/485) V5.03[29] (c)dA Switch=0x00FF Script(8k)="Leer" Author="Deutschmann Automation GmbH" Version="1.0" Date=21.08.2001 SN=47110001".

In the configuration mode the Gateway always operates with the settings 9600 Bauds, no Parity, 8 databits and 1 stopbit, the RS-State LED will always be flashing red, the "Error No/Select ID" LEDs are of no account for the user. All software revisions contain the configuration mode.

4.2 Test mode

Setting of the test mode

The test mode is set by bringing the switches S4 and S5 in position "E". All other switches will not be taken into consideration for the setting of the test mode. Now the Gateway has to be restarted with these settings (by a short disconnection from the power supply).

In the test mode the Gateway always operates with the settings 9600 baud, no parity, 8 databits and 1 stopbit.

The test mode may be helpful to integrate the Gateway in the relevant environment, for instance to test the parameters of the RS-interfaces.

Mode of operation of the test mode

After the restart in the test mode the Gateway will be sending the values 0-15 in hexadecimal representation ("0".."F") in ASCII-coding on the serial side every second. Simultaneously the same values are issued binary on the fieldbus-interface.

In this mode the State-LED on the RS-side will be flashing red, the "Error No/Select ID" LEDs will be displaying the value in a binary way, that is issued that moment. Additionally each character that is received at one of the interfaces will also be output at the same interface as a local echo. On the fieldbus-side only the first byte will be used for the local echo, that means on receiving as well as on transmitting only the first byte of the bus data is looked at, the other bus data do not change compared to the last data.

4.3 Data exchange mode

The Gateway has to be in the data exchange mode, so that a data exchange between the RS-side of the Gateway and the fieldbus is possible. As long as the Gateway is not in the configuration mode or the test mode, the data exchange mode is active. In the data exchange mode the Gateway will execute the downloaded Script.

5 RS-interface

5.1 RS-interfaces at the UNIGATE® CL

The UNIGATE® CL - DeviceNet has the interfaces RS232, RS422 and RS485 available. The hardware always features a DEBUG-interface, see chapter 7.

5.2 Buffer sizes at the UNIGATE® CL

UNIGATE® CL features at the serial side a buffer with the size of 1024 bytes for input data and output data each.

The FIFO of the application interface (RS-interface) can be changed in any Gateway form Script revision 26 on, that is capable for Script. For it please check in the Protocol Developer under "Device Control" - "Hardware".

5.3 Framing Check

The length of the stop bit received by the Gateway is checked through the function "Framing Check". Here the stop bit generated by the Gateway is always long enough, so that connected participants can evaluate the stop bit.

Please be aware that the function "Framing Check" becomes effective only in case of 8 data bit and the setting "No parity".

An error is detected and indicated by the Error LEDs in case the stop bit does not show the length 1 bit during the activated check.

The possible setting for this parameter can be controlled by the Script (see online help from Protocol Developer). The presetting for the "Stop Bit Framing Check" is "enabled".

6 SSI-interface

The UNIGATE® also supports the connection of applications or products, that communicate via SSI.

6.1 Initiation of the SSI-interface

The required Script (`example_SSI`), the firmware- (`Cust0023`) and Protocol Developer-extension (`Cust_ssi.xml`) are available free of charge from our website at www.deutschmann.de, as well as the softwaretool Protocol Developer and the configuration software WINGATE.

- In the Protocol Developer (see chapter 7, The Debug-interface) the ConfigFile "`Cust_ssi.xml`" has to be added. At Options -> Settings -> ConfigFiles.
- Load the Script "`example_SSI.dss`" into the Protocol Developer.
- The encoder type and the clock frequency has to be defined in the Script itself under "`Set number of bits`" and "`Set type and clock stretch value`" (default = 12-Bit-Single-Turn-Gray, max. clock stretch):

```
// Set number of bits
// 1..16 = Single Turn
// 17..32 = Multi Turn
moveconst (bNumBits, 12); // i.e. 12 bit single turn
// MT SSI 4096 x 4096 = 16777216 = 0b100000000000000000000000 => 24 bit

//-----
// Set type and clock stretch value
// Type (low nibble):
// 0 = Reserved
// 1 = output value as is (i.e. binary encoder)
// 2 = convert Gray encoded output value to binary (i.e. Gray encoder)
// >2 = Reserved
//
// Clock stretch value (high nibble):
// Please note that the given frequency values are only a rough estimate. The
// exact frequency varies depending on the devices underlying architecture.
// 0 = No Stretch --> ~300 kHz
// 1 = ~185 kHz
// 2 = ~150 kHz
// 3 = ~125 kHz
// 4 = ~110 kHz
// 5 = ~100 kHz
// 6 = ~ 88 kHz
// 7 = ~ 80 kHz
// 8 = ~ 72 kHz
// 9 = ~ 67 kHz
// A = ~ 62 kHz
// B = ~ 58 kHz
// C = ~ 54 kHz
// D = ~ 50 kHz
// E = ~ 48 kHz
// F = ~ 45 kHz
//moveconst ( wTyp, 0x02); // i.e. Gray encoder, no clock stretch (High-Nibble=0)
```

moveconst (wTyp, 0xF2); // i.e. Gray encoder, max clock stretch (High-Nibble=F)

- Load the Script into the device. Open WINGATE and activate the device in the configuration mode (see chapter 4.1, Configuration mode (config mode)) - an actuation message appears, that looks in line with the following (example CL-PB):
Special Firmware (23) not loaded
RS-PBV1-CL (232/422/485) V7.31[30] (c)dA Switch=0x02FF Script(8k)="SSI"
Author="Deutschmann Automation" Version="V 1.0" Date=20.03.2008 SN=47110002 ID=2
Konfigmode...
The note "Special Firmware (23) not loaded" means that the firmware-extension is not yet loaded. The extension is loaded through Extras -> Firmware Script Extension. Select the file "Cust0023 (Cmd 23 + 24 for SSI).hex" and choose "write extension".
- Re-start the device -> now only the device's actual actuation message appears and not the note any more.
- Bring the device into the data exchange mode (see chapter 4.3, Data exchange mode) -> DONE!

6.2 Hardware-wiring

The clock wires of the SSI-interface are placed onto the Tx-wires of the RS422-interface and the data wires onto the Rx-wires at the UNIGATE® CL.

X1 (3-pin + 4-pin screw-plug-connector):

Pin no.	Name	Function at SSI
1	Rx 232	n. c.
2	Tx 232	n. c.
3	AP-GND	n. c.
4	Rx 422+	SSI DAT+
5	Rx 422-	SSI DAT-
6	Tx 422+	SSI CLK+
7	Tx 422-	SSI CLK-

7 The Debug-interface

7.1 Overview of the Debug-interface

The UNIGATE® IC features a Debug-interface, that allows a step-by-step processing of a Script. Normally this interface is only required for the development of a Script.

7.2 Starting in the Debug-mode

When applying power to the UNIGATE® (power up) the firmware will output the binary character 0 (0x00) after a self-test was carried out on this interface. If the UNIGATE® receives an acknowledgement via this interface within 500 ms, it is in the Debug-mode. The acknowledgement is the ASCII-character O (0x4F).

With the start in the Debug-mode the further execution of Script commands will be put to a stop.

7.3 Communication parameter for the Debug-interface

The Debug-interface is always operating with 9600 baud, no parity, 8 data bit, 1 stop bit. It is not possible to change this parameter in the Protocol Developer. Please consider the fact that these settings have to be in accordance with those of the PC-COM-interface and that the flow control (protocol) has to be set on „none“ there.

7.4 Possibilities with the Debug-interface

Usually the Protocol Developer is connected to the Debug-interface. With it a step-by-step processing of a Script, monitoring jumps and decisions and looking at memory areas is possible. Moreover breakpoints can be set. It basically possesses all characteristics a software-development tool is typically supposed to have. However, it is also possible to carry out a Scrip-update via this interface.

From Script version [27] on you can also output data with the Script command "SerialOutputToDebugInterface". Please also pay attention to the remark in the manual 'Protocol Developer'.

7.5 Commands of the Debug-interface

The commands for the use of the Debug-interface are described in the instruction manual Protocol Developer.

8 Mode of operation of the system

8.1 General explanation

Communication can be split into seven layers, Layer 1 to Layer 7, in accordance with the ISO/OSI model.

The Deutschmann Automation Gateways convert Layers 1 and 2 of the customized bus system (RS485 / RS232 / RS422) to the corresponding Fieldbus system. Layers 3 to 6 are blank, and Layer 7 is converted in accordance with chapter 8.3.

8.2 Interfaces

The Gateway features the RS232-, RS422- and RS485-interfaces.

8.3 Data exchange DeviceNet

All data is transferred by the Gateway in dependence of the downloaded Script.

In the DeviceNet the gateway acts as a "Group 2 Only Slave". The access method "Polling", is supported, which is described below.

8.3.1 Polling

In the event of Polling the DeviceNet-master sends a telegram according to the configured length to the gateway. The gateway sends out these data via the RS-interface according to the selected protocol. As an answer the DeviceNet-master receives the latest data received by the RS-interface.

The maximum amount of input- out output data to be configured is 255 Byte.

8.4 Possible data lengths

The table below shows the maximum transferable data in DeviceNet:

Input data (Consumed)	max. 255 bytes	Variable: maximum value in this case
Output data (Produced)	max. 255 bytes	Variable: maximum value in this case

9 Generating a Script

9.1 What is a Script?

A Script is a sequence of commands, that are executed in that exact order. Because of the fact that also mechanisms are given that control the program flow in the Script it is also possible to assemble more complex processes from these simple commands.

The Script is memory-oriented. It means that all variables always refer to one memory area. While developing a Script you do not have to take care of the memory management though. The Protocol Developer takes on this responsibility for you.

9.2 Memory efficiency of the programs

A Script command can carry out e. g. a complex checksum like a CRC-16 calculation via data. For the coding of this command only 9 byte are required as memory space (for the command itself). This is only possible when these complex commands are contained in a library.

A further advantage of this library is, that the underlying functions have been in practical use for a couple of years and therefore can be described as 'void of errors'. As these commands are also present in the native code for the controller, at this point also the runtime performance of the Script is favorable.

9.3 What can you do with a Script device?

Our Script devices are in the position to process a lot of commands. In this case a command is always a small firmly outlined task. All commands can be put into classes or groups. A group of commands deals with the communication in general. This group's commands enable the Gateway to send and receive data on the serial side as well as on the bus-side.

9.4 Independence of buses

Basically the Scripts do not depend on the bus, they are supposed to operate on. It means that a Script which was developed on a PROFIBUS Gateway can also be operated on an Interbus without changes, since the functioning of these buses is very similar. In order to also process this Script on an Ethernet Gateway, perhaps further adjustments have to be made in the Script, so that the Script can be executed reasonably.

There are no fixed rules how which Scripts have to operate properly. When writing a Script you should take into account on which target hardware the Script is to be executed, so the necessary settings for the respective buses can be made.

9.5 Further settings at the Gateway

Most devices require no further adjustments, except for those made in the Script itself. However, there are also exceptions to it. These settings are made by means of the software WINGATE. If you know our UNIGATE®-series, you are already familiar with the proceeding with it. An example is the adjustment of the IP-address and the net-mask of an Ethernet-Gateway. These values have to be known as fixed values and are not available for the runtime. Another reason for the configuration of the values in WINGATE is the following: After an update of the Script these values remain untouched, i. e. the settings that were made once are still available after a change of the Script.

Only this way it is also possible that the same Script operates on different Ethernet-Gateways, that feature different IP-addresses.

9.6 The use of the Protocol Developer

The Protocol Developer is a tool for an easy generation of a Script for our Script Gateways. Its operation is exactly aimed at this use. After starting the program the Script that was loaded the last time is loaded again, provided that it is not the first start.

Typical for Windows Script commands can be added by means of the mouse or the keyboard. As far as defined and required for the corresponding command, the dialog to the corresponding command is displayed, and after entering the values the right text is automatically added to the Script. The insertion of new commands by the Protocol Developer is carried out in a way that existing commands will not be overwritten. Generally a new command is inserted in front of the one where the cursor is positioned. Of course the commands can also be written by means of the keyboard or already written commands can also be modified.

9.7 Accuracies of the baud rates

The baud rate of the serial interface is derived from the processor's crystal frequency.

Meanwhile all Script-Gateways are working with a crystal frequency of 40 MHz.

You can enter any desired integer baud rate into the Script. After that the firmware adjusts the baud rate, that can be derived the most precisely from the crystal frequency.

The baud rate the Gateway is actually working with (BaudIst) can be determined as follows:

$$\text{BaudIst} = (\text{F32} / \text{K})$$

$$\text{F32} = \text{Crystal frequency [Hz]} / 32$$

$$\text{K} = \text{Round}(\text{F32} / \text{BaudSoll});$$

Round () is a commercial roundoff

Example:

The actual baud rate is to be calculated, when 9600 baud are pre-set, where the Gateway is operated with 40 MHz:

$$\text{F32} = 40000000 / 32 = 1250000$$

$$\text{K} = \text{Round}(1250000 / 9600) = \text{Round}(130.208) = 130$$

$$\text{BaudIst} = 1250000 / 130 = 9615.38$$

I. e.: The baud rate actually adjusted by the Gateway is 9615.38 baud

The resulting error in per cent can be calculated as follows:

$$\text{Error}[\%] = (\text{abs}(\text{BaudIst} - \text{BaudSoll}) / \text{BaudSoll}) * 100$$

In our example the following error results:

$$\text{Error} = (\text{abs}(9615.38 - 9600) / 9600) * 100 = 0.16\%$$

In practise errors below 2% can be tolerated!

In the following please find a listing of baud rates at a 40 MHz-crystal frequency with the corresponding errors:

4800 baud:	0.16%
9600 baud:	0.16%
19200 baud:	0.16%
38400 baud:	1.35%
57600 baud:	1.35%
62500 baud:	0%
115200 baud:	1.35%
312500 baud:	0%
625000 baud:	0%

9.8 Script processing times

The Script is translated by the Protocol Developer and the consequently generated code is loaded into the Gateway. Now the processor in the Gateway interprets this code. In this case, there are commands that can be processed very fast (e. g. "Set Parameter"). There are also commands, however, that take longer (e. g. copying 1000 bytes). Consequently, for one thing the processing time differs due to the kind of Script command. But the processing time of the Script commands is considerably more determined by the processor time that is available for this process. Since the processor has to carry out several tasks simultaneously (multitasking system) only a part of the processor's capacity is available for the Script processing. The following tasks - in the order of priority - are executed on the processor:

- Sending and receiving data at the Debug-interface (provided that the Protocol Developer has been started on the PC)
- Sending and receiving data at the RS-interface
- Sending and receiving data at the Fieldbus-interface
- Tasks controlled via internal clock (1 ms) (e. g. flashing of an LED)
- Processing of the Script

From experience approximately 0.5 ms can be calculated for each Script line. This value confirmed itself again and again in many projects as a standard value. He is always quite right if the processor has enough time available for the Script processing.

By means of the tasks mentioned above, the following recommendation can be formulated in order to receive a rather fast Script processing:

- Deactivate the Debug-interface (it is the normal case in the serial use)
- Keep the data length at the RS-interface as small as possible. The baud rate is not the problem here, but the amount of characters which are transferred per second.
- Do not unnecessarily extend the data length at the Fieldbus side. Especially at acyclical bus data, if possible do only send them when changes were made. The data length at buses that are configured to a fixed length (e. g. PROFIBUS) should not be longer than absolutely necessary.

If the processing time should be too large in spite of these measures, there is the possibility to generate a customized Script command, that executes several tasks in one Script command. Please contact our support department for this purpose.

10 Implemented protocols in UNIGATE® CL with Universal Script

UNIGATE® CL is supplied with the Script "Universal Script Deutschmann". The configuration of the protocols is carried out by means of the software WINGATE. See "Instructions UNIGATE® CL - Configuration with WINGATE". The PDF can also be found on our website under Support/Support/Downloads/Manuals.

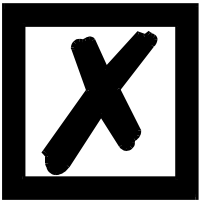

Attention:

If a Reset Device is carried out it is possible (depending on the firmware version of the UNIGATE) that the "Universal Script" will get lost and must be played in again.

The Script can be found on the Deutschmann Support-DVD in the folder \Software\ProtocolDeveloper\Example\Universal\

10.1 Protokoll: Transparent

The data is transferred bidirectional from the UNIGATE®.

10.1.1 Data structure

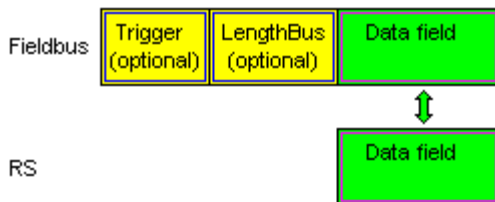

The required data length has to be configured in WINGATE via the parameters "blocklength fieldbus input" and "blocklength fieldbus output". Data that is received via RS is "collected" and it is not transferred to the bus until the length that is set in WINGATE is reached. Too many received data is "kept" and it is not written on the bus until the next transmission.

10.2 Protocol: Universal 232



The protocol designation "Universal 232" and the relation to the "RS232-interface" in the description have evolved over the years. The protocol also works with RS422 and RS485 though!

10.2.1 Data structure

Data structure Universal 232 protocol

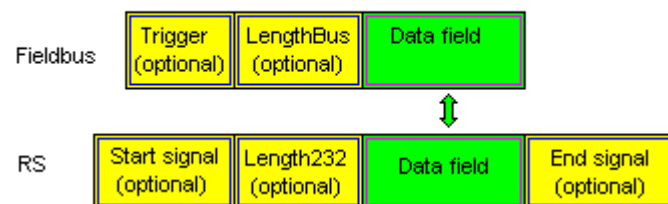

10.2.2 Fieldbus parameters

Trigger byte: See "The trigger byte", Chapter 10.5, on page 27

Length byte: See "The length byte", Chapter 10.6, on page 27

10.2.3 RS232 parameter table

10.2.3.1 Start character (232 Start character)

If this character is defined, the gateway evaluates only the data at the RS232 interface following this start character. Each transmission from the gateway via the RS232 interface is initiated with the start character in this case.

10.2.3.2 Length 232 (232 Length)

If this byte is activated, the gateway, at the receive end, awaits as many bytes of useful data as specified in this byte by the RS232 transmitter. At the transmission end, the gateway then sets this byte to the number of useful data items transmitted by it. If byte "Length232" is not defined, the gateway, on reception at the RS232 interface, waits for the end criterion if this is defined. If no end criterion is defined either, as many characters as can be transferred in the fieldbus transmit buffer are read in via the RS232 interface.

As a special case for this parameter also a length byte with additional Timeout monitoring can be set in WINGATE. In that case the received characters will be discarded at a Timeout.



Attention:

If "Timeout" is selected as end character, then this byte has no significance.

10.2.3.3 End character (232 End character)

If this character is defined, the gateway receives data from the RS232 interface up to this character. The "Timeout" criterion can be defined as a special case. In this case, the gateway continues to receive characters until a defined pause occurs. In the special case "Timeout" the "Length 232-byte" has no significance. At the transmit end, the gateway inserts the end character, if defined, as the last character of a transmission.

10.2.4 Communication sequence

The useful data (data area) arriving via the fieldbus is copied in accordance with chapter 10.2.1 transparently into the RS232 data field and transferred via the RS interface, whereby the protocol is supplemented in accordance with the configuration (start character, end character...). NO acknowledgement is issued!

If the "Trigger byte" (see chapter 10.5) is active, data is sent only on a change of this byte. If the "Length byte" (see chapter 10.6) is active, only as many of the following bytes as specified there are transferred.

Receive data at the RS interface is evaluated in accordance with the configured protocol, and the data field (data area (see chapter 10.2.1)) is sent to the fieldbus Master. If more characters have been received than the fieldbus block length, the trailing bytes are truncated and an Rx Overrun is indicated. If less have been received, padding with 0 occurs. If the "Length byte" is active, the number of received useful data items is entered there. If the, "Trigger byte" is active, this is incremented by one after each complete reception operation at the RS interface.

10.3 Protocol: 3964(R)

The 3964 protocol is used to transfer data between two serial devices. One partner must be a high-priority partner and the other must be a low-priority partner in order to resolve initialisation conflicts.

10.3.1 Data structure 3964R

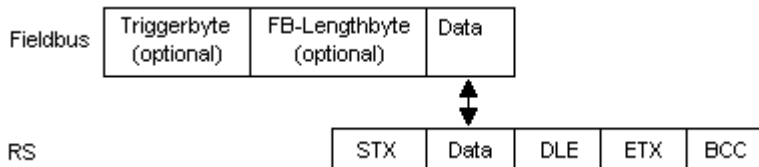

10.3.2 Protocol definitions

The telegram format is as follows:

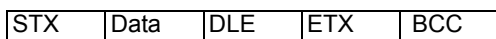

- The received net data is forwarded (transparently) in both directions unchanged.
Attention: The DLE-doubling is excluded from it; that means one DLE (10H) on the bus-side is sent on the RS-side twice. A double DLE on the RS-side is only sent once to the bus-master.
- Data blocking is not scheduled.
- The net data length is restricted to 236 bytes per telegram.
- Communication always runs between high-priority and low-priority communication partners.

10.3.3 Data communication

10.3.3.1 Initiation of data communication by the low-priority user

If the low-priority user also receives an STX in response to a transmitted STX, it interrupts its transmit request, reverts to Receive mode and acknowledges the received STX with DLE.

A DLE in the data string is duplicated and included in the checksum. The BCC is computed from XORing all characters.

10.3.3.2 Conflicts

10.3.3.3 Timeout times

The timeout times are preset by the definition of the 3964R protocol and cannot be overwritten !!!
 tq = acknowledgement timeout time (2 s).

The acknowledgement timeout time is started after transmission of control character STX. If no positive acknowledgement arrives within the acknowledgement timeout time, the job is repeated (max. 2 x). If it has not been possible to complete the job positively after two repetitions, the high-priority device nevertheless attempts to establish contact with the low-priority partner by transmitting STX (cycle corresponds to tq).

tz = character timeout time (200 ms)

If the 3964 R driver receives data, it monitors arrival of the individual characters within period tz. If no character is received within the timeout time, the protocol terminates transfer. No acknowledgement is sent to the coupling partner.

10.3.3.4 Retries

In the event of negative acknowledgement or timeout, a telegram transmitted by the high-priority user is repeated twice. After this, the gateway signals communication as disturbed but still attempts to re-establish the connection.

10.3.3.5 Initiation of data communication by the high-priority user

In the case of a negative acknowledgement or timeout, a telegram transmitted by the external device is repeated twice before a fault is signalled.

10.3.4 Protocol type 3964

The difference to protocol type 3964R is:

1. tq = acknowledge monitoring time
2. The checksum byte BCC is missing.

10.4 Protocol: MODBUS-RTU

10.4.1 Notes

- For reasons of simplicity, "MODBUS-RTU" is referred to as "MODBUS" in the text below.
- The terms "input" and "output" are always viewed from the gateway's point of view, i.e. fieldbus input data is the data sent by the fieldbus Master to the gateway.

10.4.2 UNIGATE as MODBUS-Master

10.4.2.1 Preparation

Before data exchange is commenced, the parameters "Baud rate", "Parity", "Start bits", "Stop bits" and "Data bits" and, if applicable, the "Trigger byte" and the "Length byte" must be set.

In addition, a "Response time" which corresponds to the maximum time up to which the Modbus Slave responds after a request must be set. UNIGATE multiplies the value entered in WINGATE by 10 ms.

Since the Modbus operates with a variable data format - dependent on the required function and data length - but since the fieldbus requires a fixed data length, this must be preset via the configuration with WINGATE (blocklength fieldbus input and blocklength fieldbus output). This length should be selected by the user such that the longest Modbus request resp. response can be processed.

The user can choose whether the fieldbus requests are forwarded to the Modbus in an event-driven way (On Event) or on request (On Trigger).

The mode "Modbus request on demand" necessitates the first byte in the fieldbus containing a trigger byte (see chapter 10.5). This byte is not transferred to the Modbus and serves only to start a Modbus transmission. For this purpose, the gateway constantly monitors this trigger byte and sends data to the Modbus only when this byte has changed. In the reverse direction (to the fieldbus), the gateway transfers the number of received Modbus data records in this byte, i.e. this byte is incremented by the gateway after each data record.

If the "Length byte" is activated (see chapter 10.6), the gateway transfers only the number of bytes specified there. The number of received Modbus data items is saved in the direction of the fieldbus Master. The length always refers to bytes "Address" to "Dat n" (inclusive in each case), always without CRC checksum.

10.4.2.2 Data structure

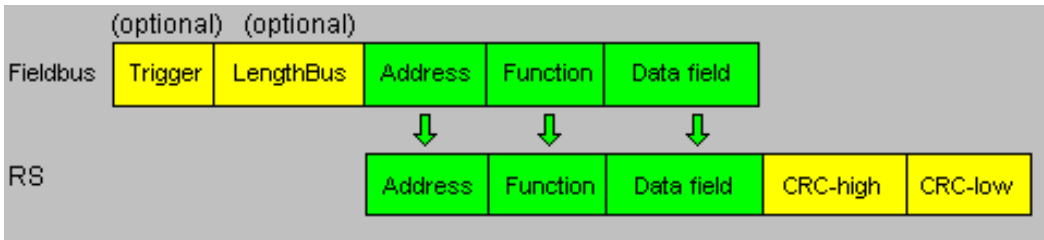

10.4.2.3 Communication sequence

The gateway always acts as the Slave with respect to the fieldbus and always acts as the Master at the Modbus end. Thus, data exchange must always be started by the fieldbus Master. The gateway fetches this data which must be structured in accordance with chapter "Data structure", from the fieldbus Master, determines the valid length of the Modbus data if the length byte is not activated, adds the CRC checksum and sends this data record as a request on the Modbus.

The response of the selected Slave is then sent to the fieldbus Master by the gateway - without CRC checksum. If no response occurs within the stipulated "Response time", the gateway signals a "TIMEOUT ERROR".

10.4.3 UNIGATE® as MODBUS-Slave

10.4.3.1 Preparation

Before data exchange is commenced, the parameters "Trigger byte" and "Length byte", "Baud rate", "Parity", "Start bits", "Stop bits" and "Data bits" must be set.

At the rotary switch on the RS-side the MODBUS-ID has to be set, under which the gateway is addressed in the Modbus.

Since the Modbus operates with a variable data format - dependent on the required function and data length - but since the fieldbus requires a fixed data length, this must be preset via the configuration with WINGATE (blocklength fieldbus input and blocklength fieldbus output). This length should be selected by the user such that the longest Modbus request resp. response can be processed.

10.4.3.2 Data structure

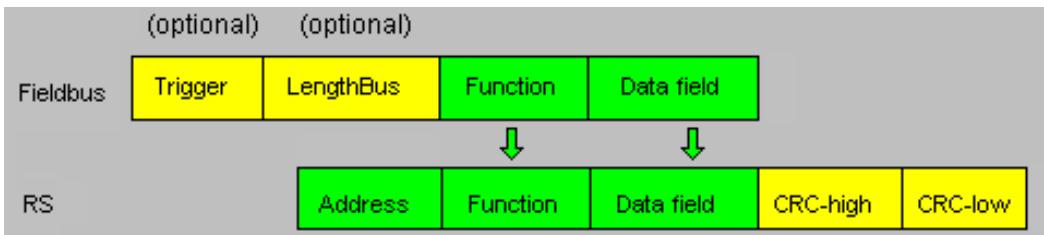

10.4.3.3 Communication sequence

The gateway always acts as the Slave with respect to the fieldbus and also acts as Slave at the Modbus end. A data exchange is always initiated by the MODBUS-Master via the RS-interface. If the Modbus-address (1st Byte) which is sent out by the Modbus-Master is identical with the address set on the gateway, the gateway sends the received data (without Modbus-address and CRC-check sum) to the fieldbus-master (look picture above). With it the gateway optionally completes as an introduction a Trigger byte and a Length byte.

The fieldbus-master detects when it has to analyse a record via the Trigger byte which is incremented by the gateway at every inquiry. The number of the following Modbus-data is to be found in the length byte.

Now the fieldbus-master has to analyse the Modbus-inquiry and it has to send back the answer in the same format (optionally with the leading Trigger byte and Length byte) via the fieldbus to the gateway.

The gateway then takes this answer and completes the Modbus-address and the CRC and sends the data to the Modbus-Master via the RS-interface. With it the data exchange is completed and the gateway waits for a new inquiry from the Modbus-Master.

10.4.4 UNIGATE® as Modbus-ASCII Master

On request!

→ For the description see chapter 10.4.2 "UNIGATE as MODBUS-Master"

10.5 The trigger byte

If data is transferred cyclically via DeviceNet (which is usually not the case), the gateway must detect when the user wishes to send new data via the serial interface. For this reason, the user can set control of transmission via a trigger byte (data exchange → On Trigger). In this mode, the gateway always sends (and only then) when the trigger byte is changed.

If the Trigger-Byte mode is activated, the gateway increments the trigger byte each time a telegram has been received.

The first byte in the DeviceNet input/output data buffer is used as the trigger byte if this mode is activated.

10.6 The length byte

The user can configure whether the transmit length is also to be stored as a byte in the input/output data area (Fieldbus lengthbyte → active). In transmit direction, as many bytes as specified in this byte are sent. On reception of a telegram the gateway enters the number of characters received.

11 Hardware ports, switches and LEDs

11.1 Device labeling

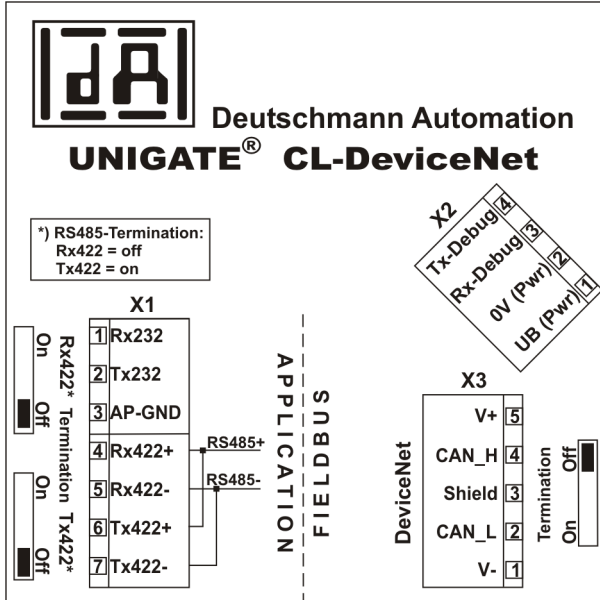

Picture 1: Terminal labeling and termination

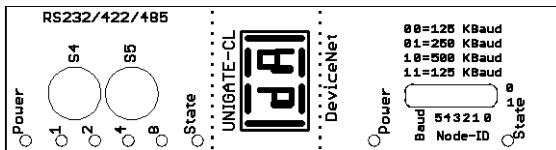

Picture 2: Front panel: Rotary switches, DIP-switch and LEDs

11.2 Connectors

11.2.1 Connector to the external device (RS-interface)

The serial interface is available at the plug accessible on the upper side of the device.

Pin assignment X1 (3-pole and 4-pole screw-type plug connector)

Pin No.	Name	Function
1	Rx 232	Receive signal
2	Tx 232	Transmit signal
3	AP-GND	Application Ground
4	Rx 422+ (485+)	Receive signal
5	Rx 422- (485-)	Receive signal
6	Tx 422+ (485+)	Transmit signal
7	Tx 422- (485-)	Transmit signal

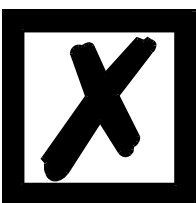

For the operation at a 485-interface the two pins labeled "485-" have to be connected together.
Also the two pins "485+".

11.2.2 Connector supply voltage and DEBUG-interface

Pin assignment X2 (4-pole screw-plug connector, on the bottom side, at the back)

Pin No.	Name	Function
1	UB (Pwr)	10..33 V supply voltage / DC
2	0 V (Pwr)	0 V supply voltage / DC
3	Rx-Debug	Receive signal Debug
4	Tx-Debug	Transmit signal Debug

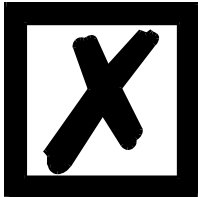

Attention:

At isolated devices (option GT) Ground for the DEBUG-Interface must be connected with pin 3 (AP-GND) of the RS-interface!

At devices that are not isolated also the 0V (Pwr)-signal can be used as reference.

11.2.3 DeviceNet-connector

The plug (labeled: DeviceNet) for the connection to DeviceNet is available on the lower side of the device.

Pin assignment X3 (5-pole screw-plug connector)

Pin No.	Name	Function
1	V-	Supply voltage DeviceNet 0 V
2	CAN-L	Dominant Low
3	Shield	Cable shield
4	CAN-H	Dominant High
5	V+	Supply voltage DeviceNet 24 V

11.2.4 Power supply

The device must be powered with 10-33 VDC, The voltage supply is made through the 4-pole screw-plug connector at the device's bottom side.

Please note that the devices of the series UNIGATE[®] should not be operated with AC voltage.

11.3 LEDs

The Gateway UNIGATE[®] CL - DeviceNet features 8 LEDs with the following significance:

LED (Bus) Power	green	Supply voltage DeviceNet
LED (Bus) State	red/green	Interface state DeviceNet
LED Power	green	Supply voltage serial interface
LED State	red/green	User-defined / general Gateway error
LEDs 1 / 2 / 4 / 8 (Error No. / Select ID)	green	User-defined / general Gateway error

11.3.1 LED "(Bus) Power"

This LED is connected directly to the electrically isolated supply voltage of the DeviceNet-side.

11.3.2 LED "(Bus) State"

This LED operates as combined "Module/Network Status LED" according to DeviceNet-Specification.

Lights green	Gateway connected to master
Blinks green	No connection to DeviceNet-master
Blinks red	Errors that can be removed (e. g. Timeout)
Lights red	Serious error (e. g. double MAC-ID)
Blinks red/green	Communication error

11.3.3 LED "Power"

This LED is connected directly to the (optionally also electrically isolated) supply voltage of the serial interface (RS232/422/485).

11.3.4 LED "State"

Lights green	Controllable via Script
Flashes green	Controllable via Script
Flashes green/red	Controllable via Script
Lights red	General Gateway error (see LEDs Error No.), controllable via Script
Flashes red	UNIGATE is in the configuration / test mode, controllable via Script

11.3.5 LEDs 1 / 2 / 4 / 8 (Error No. / Select ID)

If these 4 LEDs flash and LED "State" simultaneously lights red, the error number is displayed in binary notation (conversion table, see Annex) in accordance with the table in chapter "Error handling". Additionally there LEDs are controllable via Script.

11.4 Switches

The Gateway features 6 switches with the following functions:

Termination Rx 422	switchable Rx 422-terminating resistor for the serial interface
Termination Tx 422	switchable Tx 422- or RS485-terminating resistor for the serial interface
Rotary coding switch S4	ID High for serial interface i. e. configmode
Rotary coding switch S5	ID Low for serial interface i. e. configmode
Termination (DeviceNet)	switchable DeviceNet-terminating resistor
DIP-switch	Node-ID and baud rate

11.4.1 Termination Rx 422 + Tx 422 (serial interface)

If the Gateway is operated as the physically first or last device in an RS485-bus or as 422, there must be a bus termination at this Gateway. In order to do this the termination switch is set to position ON. The resistor (150 Ω) integrated in the Gateway is activated. In all other cases, the switch remains in position OFF.

Please refer to the general RS485 literature for further information on the subject of bus terminations.

If the integrated resistor is used, please allow for the fact that this also activates a pull-down resistor (390 Ω) to ground and a pull-up resistor (390 Ω) to VCC.

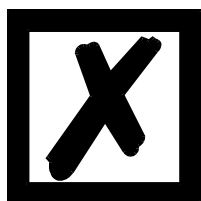

**At RS48 only the Tx 422-switch must be set to ON.
The Rx 422-switch has to be on OFF.**

11.4.2 Rotary coding switches S4 + S5 (serial interface)

These two switches can be read out through the Script command "Get (RS_Switch, Destination)" and the value can be used for further functions. This value is read in when the Gateway is switched on or always after a Script command has been executed. The switch positions "EE" (testmode) and "FF" (config mode) are not possible for RS422- or RS485-operation.

Note: The switch position "DD" (ie, S4 and S5 in position "D") is reserved for internal purposes.

11.4.3 Termination (DeviceNet)

If the Gateway is operated as the first or last physical device in the DeviceNet, there must be a bus termination at this Gateway. In order to do this, either a bus terminating resistor must be activated in the connector or the resistor (220 Ω) integrated in the Gateway must be activated. In order to do this, slide the slide switch to position ON. In all other cases, the slide switch must remain in position OFF. Please refer to the general Fieldbus literature for further information on the subject of bus termination.

11.4.4 DIP-switch

The DIP-switch is used to set the Node-ID and baud rate according to picture 3.

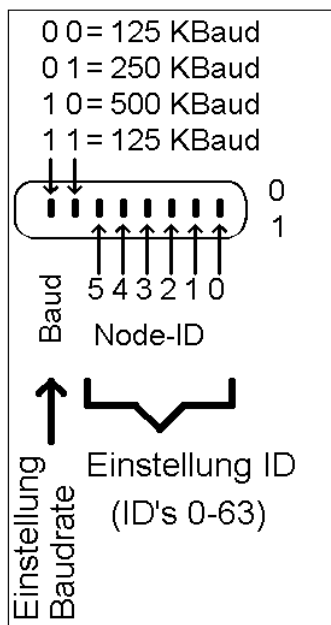

Picture 3: DIP-switch

11.5 The Debug cable for UNIGATE® CL

As accessory a pre-configured Debug cable is available. The Debug cable connects the Gateway to Debug and RS.

12 Error handling

12.1 Error handling at UNIGATE® CL

If the Gateway detects an error, the error is signalled by the "State" LED lighting red and, simultaneously, the error number being indicated by means of LEDs "Error No." as shown in the table below. A distinction can be made between two error categories:

Serious errors (1-5): In this case, the Gateway must be switched off and switched back on again. If the error occurs again, the Gateway must be exchanged and returned for repair.

Warnings (6-15): These warnings are displayed for one minute simply for information purposes and are then automatically reset. If such warnings occur frequently, please inform After-Sales Service.

For user-defined errors the flash frequency is 0.5 hertz. The error is displayed as long as defined by "Set Warning Time".

In the configuration mode these displays are not valid and only meant for internal use.

LED8	LED4	LED2	LED1	Error no. resp. ID	Error description
0	0	0	0	0	Reserved
0	0	0	1	1	Hardware fault
0	0	1	0	2	EEROM error
0	0	1	1	3	Internal memory error
0	1	0	0	4	Fieldbus hardware error or wrong Fieldbus-ID
0	1	0	1	5	Script error
0	1	1	0	6	Reserved
0	1	1	1	7	RS-transmit buffer overflow
1	0	0	0	8	RS-receive buffer overflow
1	0	0	1	9	RS timeout
1	0	1	0	10	General fieldbus error*
1	0	1	1	11	Parity-or frame-check-error
1	1	0	0	12	Reserved
1	1	0	1	13	Fieldbus configuration error
1	1	1	0	14	Fieldbus data buffer overflow
1	1	1	1	15	Reserved

Table 1: Error handling at UNIGATE® CL

*) The system error 10 is always displayed when one of the following errors appears:

Error	Error value
DUP_MAC_ERROR	0x0001
RX_QUEUE_OVERRUN	0x0002
TX_QUEUE_OVERRUN	0x0004
IO_SEND_ERROR	0x0008
CAN_BUS_OFF	0x0010
CAN_OVERRUN	0x0020
EXPL_CNXXN_TIMEOUT 1)	0x0040
IO_CNXXN_TIMEOUT	0x0080
IO_CNXXN_DELETE	0x0100
DNS_RESET	0x0200
DNS_BUS_SENSE_ERROR	0x0400

1) Timeout = Expected Packed Rate * 4!

With the Script command "Get (DetailErrorCode, w_Error)" the above value can be read out and with it it can be exactly determined, what error was the actuator.

13 Installation guidelines

13.1 Installation of the module

The module with the dimensions 23 x 115 x 116 mm (W x D x H) has been developed for switch cabinet use (IP 20) and can thus be mounted only on a standard mounting channel (deep DIN-rail to EN 50022).

13.1.1 Mounting

- Engage the module from the top in the top-hat rail and swivel it down so that the module engages in position.
- Other modules may be rowed up to the left and right of the module.
- There must be at least 5 cm clearance for heat dissipation above and below the module.
- The standard mounting channel must be connected to the equipotential bonding strip of the switch cabinet. The connection wire must feature a cross-section of at least 10 mm².

13.1.2 Removal

- First disconnect the power supply and signal lines.
- Then push the module up and swivel it out of the top-hat rail.

Vertical installation

The standard mounting channel may also be mounted vertically so that the module is mounted turned through 90°.

13.2 Wiring

13.2.1 Connection systems

The following connection systems must resp. may be used when wiring the module:

- Standard screw-type/plug connection (power supply + RS + DeviceNet)
- a) In the case of standard screw-type terminals, one lead can be clamped per connection point. It is best to then use a screwdriver with a blade width of 3.5 mm to firmly tighten the screw.

Permitted cross-sections of the line:

- Flexible line with wire-end ferrule: 1 x 0.25 ... 1.5 mm²
- Solid conductor: 1 x 0.25 ... 1.5 mm²
- Tightening torque: 0.5 ... 0.8 Nm

b) The plug-in connection terminal strip is a combination of standard screw-type terminal and plug connector. The plug connection section is coded and can thus not be plugged on the wrong way round.

13.2.1.1 Power supply

The device must be powered with 10..33 V DC.

- Connect the supply voltage to the 4-pole plug-in screw terminal in accordance with the labelling on the device.

13.2.1.2 Equipotential bonding connection

The connection to the potential equalization automatically takes place if it is put on the DIN-rail.

13.2.2 DeviceNet communication interface

13.2.2.1 Bus line with copper cable

This interface is located on the module in the form of a 5-pin screw-plug-connector on the lower side of the housing.

- Plug the DeviceNet connecting plug onto the socket labelled "DeviceNet".
- If the module is located at the start or end of the DeviceNet line, you must switch on the bus terminating resistor integrated in the gateway. In order to do this, slide the sliding switch to the position labelled ...on...
- If the module is not located at the start or at the end, you must set the sliding switch to position "off".

13.2.3 Line routing, shield and measures to combat interference voltage

This chapter deals with line routing in the case of bus, signal and power supply lines, with the aim of ensuring an EMC-compliant design of your system.

13.2.4 General information on line routing

- Inside and outside of cabinets

In order to achieve EMC-compliant routing of the lines, it is advisable to split the lines into the following line groups and to lay these groups separately.

- ⇒ Group A:
 - shielded bus and data lines (e. g. for ProfibusDP, RS232C and printers etc.)
 - shielded analogue lines
 - unshielded lines for DC voltages ≥ 60 V
 - unshielded lines for AC voltage ≥ 25 V
 - coaxial lines for monitors
- ⇒ Group B:
 - unshielded lines for DC voltages ≥ 60 V and ≥ 400 V
 - unshielded lines for AC voltage ≥ 24 V and ≥ 400 V
- ⇒ Group C:
 - unshielded lines for DC voltages > 400 V

The table below allows you to read off the conditions for laying the line groups on the basis of the combination of the individual groups.

	Group A	Group B	Group C
Group A	1	2	3
Group B	2	1	3
Group C	3	3	1

Table 3: Line laying instructions as a function of the combination of line groups

- 1) Lines may be laid in common bunches or cable ducts.
- 2) Lines must be laid in separate bunches or cable ducts (without minimum clearance).
- 3) Lines must be laid in separate bunches or cable ducts inside cabinets but on separate cable racks with at least 10 cm clearance outside of cabinets but inside buildings.

13.2.4.1 Shielding of lines

Shielding is intended to weaken (attenuate) magnetic, electrical or electromagnetic interference fields.

Interference currents on cable shields are discharged to earth via the shielding bus which is connected conductively to the chassis or housing. A low-impedance connection to the PE wire is particularly important in order to prevent these interference currents themselves becoming an interference source.

Wherever possible, use only lines with braided shield. The coverage density of the shield should exceed 80%. Avoid lines with foil shield since the foil can be damaged very easily as the result of tensile and compressive stress on attachment. The consequence is a reduction in the shielding effect.

In general, you should always connect the shields of cables at both ends. The only way of achieving good interference suppression in the higher frequency band is by connecting the shields at both ends.

The shield may also be connected at one end only in exceptional cases. However, this then achieves only an attenuation of the lower frequencies. Connecting the shield at one end may be more favorable if

- it is not possible to lay an equipotential bonding line
- analogue signals (a few mV resp. mA) are to be transmitted
- foil shields (static shields) are used.

In the case of data lines for serial couplings, always use metallic or metallized plugs and connectors. Attach the shield of the data line to the plug or connector housing.

If there are potential differences between the earthing points, a compensating current may flow via the shield connected at both ends. In this case, you should lay an additional equipotential bonding line.

Please note the following points when shielding:

- Use metal cable clips to secure the shield braiding. The clips must surround the shield over a large area and must have good contact.
- Downstream of the entry point of the line into the cabinet, connect the shield to a shielding bus. Continue the shield as far as the module, but do not connect it again at this point!

14 DeviceNet

14.1 The Product Code

The device's Product Code is an unsigned integer value (UINT) with values ranging between 0 and 65535 and it is included in the first instance (01 hex) of the Identity Object (01 hex) in attribute 3 (0003 hex).

There are two ways to set the Product Code via the Script:

1. If the value is set to `default = 0 [Set (ProductCode , 0) ; // default]`, then the following applies:
The Product Code is set subject to the Fieldbus length. At the same time the Produced Size of the UNIGATE presents the more significant byte and the Consumed Size the low-order byte of the Product Code.

Example:

The Produced Size = 5 byte and the Consumed Size of the UNIGATE = 3 byte,

```
Set ( BusOutputSize , 5 ) ; // produced size
```

```
Set ( BusInputSize , 3 ) ; // consumed size
```

i. e. the more significant byte is 5 and the low-order byte is 3. That implies a Product Code 0503 (hex) = 1283 (dec).

2. A fixed value can be set through the Script command `Set Product Code`.

Please note: The command has to be set after „BusOutputSize“ and „BusInputSize“:

Example:

```
Set ( ProductCode , 1234 ) ;
```

The Product Code is 1234 (hex) = 4660 (dec)

14.2 EDS file

In order to use a device with the set values in a DeviceNet network, a corresponding EDS file has to be integrated into the configuration tool.

Below you find a sample EDS file. The file (CLDN.eds) can also be downloaded from our website www.deutschmann.com.

14.2.1 Sample EDS file

CLDN.eds

```
$ EZ-EDS Version 1.0 Generated Electronic Data Sheet
```

```
$
```

```
http://www.odva.org/Home/CIPNETWORKSPECIFICATIONS/Order/Software/EZEDSFreeware-Download/tabid/201/Default.aspx
```

[File]

```
DescText = "Gateway DeviceNet-RS232/485/422"; $ req, display by config tool
CreateDate = 01-16-2007;
CreateTime = 13:42:00;
ModDate = 01-16-2007;
ModTime = 15:16:21;
Revision = 1.0;
```

```

[Device]    $ //TBD from user
  VendCode = 272;           $ Vendor Code
  VendName = "example Vendor Name";
  ProdType = 12;           $ Product Type
  ProdTypeStr = "Communications Adapter";
  ProdCode = 2056;         $ Product Code
  MajRev   = 2;           $ Major Rev
  MinRev   = 50;          $ Minor Rev
  ProdName = "UNIGATE-RS DeviceNet";
  Catalog  = "V3555";
  Icon     = "CLDN.ico";

[IO_Info]
  $ Parameter Class Section:
  $ For more information about the meaning of each entry, please check
  $ The CIP Network Library Volume 1 Chapter 7

  Default      = 0x0001; $ Poll Only

  PollInfo     = 0x0001, $ Poll Only
                1,      $ Default Input = Input1
                1;      $ Default Output = Output1

  $ Input Connections

  Input1       = 8,           $ produced size
                0,           $ all bits are significant
                0x0001,      $ Poll Only Connections
                "Data to SPS", $ Name
                6,
                "20 64 24 01 30 65", $ Application Object Class 100, Instance 1,
                                   Attribute 101
                "";          $ Help

  $ Output Connections

  Output1      = 8,           $ consumed size
                0,           $ all bits are significant
                0x0001,      $ Poll Only Connections
                "Data from SPS", $ Name
                6,
                "20 64 24 01 30 64", $ Application Object Class 100, Instance 1,
                                   Attribute 100
                "";          $ Help

[ParamClass]
  $ Parameter Class Section:
  $ For more information about the meaning of each entry, please check
  $ The CIP Network Library Volume 1 Chapter 7

```

```

MaxInst      = 0;      $ no parameters supported
Descriptor   = 0x0003; $ supports parameter instances and full attributes
CfgAssembly= 0;      $ not used here

```

[Params]

[Groups]

\$ End of File

Note:

1. These default-values can be changed via the Script (see the Online-Help of the Protocol Developer for it).
2. You can find an EDS-editor (EZ - EDS) using the above URL (odva.org...).

14.3 DeviceNet™ information

General information

In the DeviceNet network the UNIGATE® RS-DeviceNet operates as a Class 2 Slave. The device supports Poll connections, Change-Of-State messages and Bit Strobe of the predefined master Slave Connection Set. The device does not support "Explicit Unconnected Message Manager" (UCMM).

The device purely supports all combinations of Consumed Size and Produced Size between 1 and 255 bytes. The sizes can be chosen as desired.

Message Types

As group 2 slaves, the device supports the following message types.

CAN Identifier	Group 2 Message Type
10xxxxxx111	Duplicate MAC ID Check Message
10xxxxxx110	Unconnected Explicit Request Message
10xxxxxx101	Master I/O Poll Command Request
10xxxxxx100	Master Explicit Request Message

xxxxxx = Node Address

Class Services

As Group 2 Slave the UNIGATE® RS-DeviceNet supports the following class services and instance services.

Service Code (hex)	Group 2 Message Type
0E	Get Attribute Single
10	Set Attribute Single
4B	Allocate predefined master slave Connection Set
4C	Release predefined master slave Connection Set

Object Classes

The UNIGATE® RS-DeviceNet the following object classes.

Class (hex)	Group 2 Message Type
01	Identity
03	DeviceNet
05	Connection
64	Consumed Data
65	Produced Data

15 Technical data

15.1 Device data

The technical data of the module is given in the table below.

No.	Parameter	Data	Explanations
1	Location	Switch cabinet	DIN-rail mounting
2	Enclosure	IP20	Protection against foreign bodies and water to IEC 529 (DIN 40050)
3	Service life	10 years	
4	Housing size	23 x 115 x 116 mm (screw-plug-connector included) 23 x 115 x 100 mm (screw-plug connector not included)	W x D x H
5	Installation position	Any	
6	Weight	130 g	
7	Operating temperature	-40°C ... +85°C	
8	Storage/transport temperature	-40 °C ... +85 °C	
9	Atmospheric pressure during operation during transport	795 hPa ... 1080 hPa 660 hPa ... 1080 hPa	
10	Installation altitude	2000 m 4000 m	Unrestricted Restricted - Ambient temperature ≤ 40°C
11	Relative humidity	Max. 80 %	No condensation, no corrosive atmosphere
12	External power supply	10..33 V DC	Standard power supply unit to DIN 19240
13	Current consumption at 24 VDC	Typ. 120 mA max 150 mA	At 10.8V. typ. 350 mA
14	Reverse voltage protection	Yes	But does not function!
15	Short-circuit protection	Yes	
16	Overload protection	Poly-switch	Thermal fuse
17	Undervoltage detection (USP)	≤ 9 V DC	
18	Emergency power supply	≥ 5 ms	Device fully operable

Table: Technical data of the module

15.1.1 Interface data

The table below lists the technical data of the interfaces and ports on the device. The data has been taken from the corresponding Standards.

No.	Interface designation Physical interface	DeviceNet	RS232-C RS232-C	RS485/RS422 RS485/RS422
1	Standard	CiA [®] DS 102	DIN 66020	EIA Standard
2	Transmission mode	Symmetrical asynchronous serial half-duplex → Difference signal	Asymmetrical asynchronous serial full duplex → Level	Symmetrical asynchronous serial half-duplex full duplex at RS422 → Difference signal
3	Transmission method	Master / slave	Master / slave	Master / slave
4	Number of users: - Transmitters - Receivers	32 32	1 1	32 32
5	Cable length: - Maximum - Baud rate-dependent	500 m 125 kB → 500 m 250 kB → 250 m 500 kB → 100 m	15 m no	1200 m <93.75 kBd → 1200 m 312, kBd → 500 m 625 kBd → 250 m
6	Bus topology	Line	Point-to-point	Line
7	Data rate: - Maximum - Standard values	500 kBit/s 125 kB 250 kB 500 kB	120 kBit/s 2.4 k/B 4.8 k/B 9.6 kBit/s 19.2 kBit/s 38.4 kBit/s 57.6 kBit/s	625 kBaud 2.4 kBit/s 4.8 kBit/s 9.6 kBit/s 19.2 kBit/s 57.6 kB 312.5 kB 625 kB
8	Transmitter: - Load - Maximum voltage - Signal, unloaded - Signal, loaded	54 Ω - 7 V ... 12 V ± 5 V ± 1.5 V	3 ... 7 kΩ ± 25 V ± 15 V ± 5 V	54 Ω - 7 V ... 12 V ± 5 V ± 1.5 V
9	Receiver: - Input resistance - Max. input signal - Sensitivity	12 Ω - 7 V ... 12 V ± 0.2 V	3 ... 7 Ω ± 15 V ± 3 V	12 Ω - 7 V ... 12 V ± 0.2 V
10	Transmit range (SPACE): - Voltage level - Logic level	- 0.5 ... + 0.05 V 0	+ 3 ... + 15 V 0	- 0.2 ... + 0.2 V 0
11	Transmit pause (MARK): - Voltage level - Logic level	+ 1.5 ... +3 V 1	- 3 ... -15 V 1	+ 1.5 ... +5 V 1

Table: Technical data of the interfaces and ports on the module

16 Commissioning guide

16.1 Note

Only trained personnel following the safety regulations may commission the UNIGATE®.

16.2 Components

You will require the following components to commission the UNIGATE®:

- UNIGATE®
- Connection cable from gateway to the process
- Connector for DeviceNet connection to the Gateway
- DeviceNet™ cable (generally this cable is already installed on site!)
- 10..33 V DC power supply (DIN 19240)
- Type file or EDS file and user manual (in chapter 14.2 you can find a sample EDS file, the user manual can be ordered separately or downloaded free of charge from our homepage at www.deutschmann.de).

16.3 Installation

The UNIGATE® CL - DN module features protection type IP20 and is thus suitable for switch cabinet use. The device is designed for snapping onto a 35 mm DIN-rail.

16.4 Dimensional drawing UNIGATE® CL - DeviceNet™

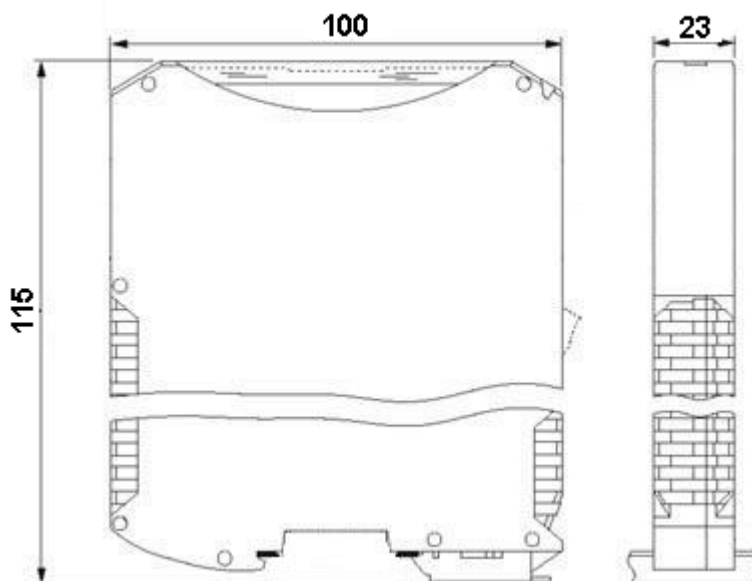

16.5 Commissioning

It is essential that you perform the following steps during commissioning in order to ensure that the module operates correctly:

16.6 Setting the DeviceNet™ address and baud rate

Set the DeviceNet-Node-ID and the baud rate at the fieldbus end of the module on the DIP-switch (see chapter 11.4.4).

**Attention:**

***The DeviceNet address set must correspond to the planned address!
All users in the DeviceNet have to use the same Baud rate!
These values are read in only on power-up of the gateway!***

16.7 DeviceNet™ connection

Connect the device to the DeviceNet at the interface labelled "DeviceNet".

16.8 Connection to the process device

Please also read the manual for the process device when commissioning the process device.

16.9 Connecting the supply voltage

Please connect 10..33 DC voltage to the terminals provided for this.

16.10 Shield connection

Earth the top-hat rail onto which the module has been snapped.

16.11 Project planning

Use any project planning tool for project planning.

If the required EDS file was not supplied with your project planning tool, you can find a sample file in chapter 14.2 or on the Internet at www.deutschmann.de.

17 Servicing

Should questions arise that are not covered in this manual you can find further information in our

- FAQ/Wiki area on our homepage www.deutschmann.com or directly in our Wiki on www.wiki.deutschmann.de

If your questions are still unanswered please contact us directly.

Please note down the following information before calling:

- Device designation
- Serial number (S/N)
- Article number
- Error number and error description

Your request will be recorded in the Support center and will be processed by our Support Team as quickly as possible (Usually in 1 working day, rarely more than 3 working days.).

Technical Support hours are as follows:

Monday to Thursday from 8 am to midday and from 1 pm to 4 pm, Friday from 8 am to midday (CET).

Deutschmann Automation GmbH & Co. KG
Carl-Zeiss-Straße 8
D-65520 Bad-Camberg
Germany

Central office and sales department +49 6434 9433-0
Technical Support +49 6434 9433-33

Fax sales department +49 6434 9433-40
Fax Technical Support +49 6434 9433-44

E-mail Technical Support support@deutschmann.de

17.1 Returning a device

If you return a device, we require as comprehensive a fault/error description as possible. We require the following information in particular:

- What error number was displayed?
- What is the supply voltage (± 0.5 V) with Gateway connected?
- What were you last doing or what last happened on the device (programming, error on power-up, ...)?

The more precise information a fault/error description you provide, the more exactly we will be able to pinpoint the possible causes.

17.2 Downloading PC software

You can download current information and software free of charge from our Internet server. <http://www.deutschmann.com>

18 Annex

18.1 Explanations of the abbreviations

General

CL	=	Product group CL (Compact Line)
CM	=	Product group CM (CANopen Line)
CX	=	Product group CX
EL	=	Product group EL (Ethernet Line)
FC	=	Product group FC (Fast Connect)
GT	=	Galvanic separation RS-side
GY	=	Housing color gray
MB	=	Product group MB
RS	=	Product group RS
SC	=	Product group SC (Script)
232/485	=	Interface RS232 and RS485 switchable
232/422	=	Interface RS232 and RS422 switchable
DB	=	Additional RS232 DEBUG-interface
D9	=	Connection of the RS through 9-pin D-SUB instead of 5-pin screw-plug connector
PL	=	Board only without DIN-rail module and without housing cover
PD	=	Board only without DIN-rail module and with housing cover
AG	=	Gateway installed in a die-cast aluminum housing
EG	=	Gateway installed in a stainless steel housing
IC	=	Product group IC (IC-design DIL32)
IO8	=	Option I/O8
16	=	Script memory expanded to 16KB
5V	=	Operating voltage 5V
3,3V	=	Operating voltage 3.3V

Fieldbus

ASI	=	AS-Interface (AS-i)
BI	=	BACnet/IP
BMS	=	BACnet MSTB
CO	=	CANopen
C4	=	CANopen V4
C4X	=	CANopen V4-version X (see comparison table UNIGATE® IC for the respective product)
DN	=	DeviceNet
EC	=	EtherCAT
EI	=	Ethernet/IP
FE	=	Ethernet 10/100 MBit
FEX	=	Ethernet 10/100 MBit-version X (see comparison table UNIGATE® IC for the respective product)
IB	=	Interbus
IBL	=	Interbus
LN62	=	LONWorks62
LN512	=	LONWorks512
ModTCP	=	ModbusTCP
MPI	=	Siemens MPI®
PL	=	Powerlink

PN = Profinet-IO
PBDP = ProfibusDP
PBDPL = ProfibusDP-version L (see comparison table UNIGATE® IC for the respective product)
PBDPX = ProfibusDP-version X (see comparison table UNIGATE® IC for the respective product)
PBDPV0 = ProfibusDPV0
PBDPV1 = ProfibusDPV1
RS = Serial RS232/485/422

18.2 Hexadecimal table

Hex	Decimal	Binary
0	0	0000
1	1	0001
2	2	0010
3	3	0011
4	4	0100
5	5	0101
6	6	0110
7	7	0111
8	8	1000
9	9	1001
A	10	1010
B	11	1011
C	12	1100
D	13	1101
E	14	1110
F	15	1111

